

Water Quality Trading in the Lake Winnipeg Basin

A multi-level trading system architecture

Vivek Voora
Matthew McCandless
Dimple Roy
Henry David Venema
Bryan Osborne
Richard Grosshans

March 2009

Prepared for Agriculture and Agri-Food Canada

Water Quality Trading in the Lake Winnipeg Basin: A multi-level trading system architecture

Vivek Voora
Matthew McCandless
Dimple Roy
Henry David Venema
Bryan Osborne
Richard Grosshans

March 2009

Prepared for Agriculture and
Agri-Food Canada

© 2010 International Institute for Sustainable
Development (IISD)

Published by the International Institute for
Sustainable Development

IISD contributes to sustainable development by advancing policy recommendations on international trade and investment, economic policy, climate change and energy, measurement and assessment, and natural resources management, and the enabling role of communication technologies in these areas. We report on international negotiations and disseminate knowledge gained through collaborative projects, resulting in more rigorous research, capacity building in developing countries, better networks spanning the North and the South, and better global connections among researchers, practitioners, citizens and policy-makers.

IISD's vision is better living for all—sustainably; its mission is to champion innovation, enabling societies to live sustainably. IISD is registered as a charitable organization in Canada and has 501(c)(3) status in the United States. IISD receives core operating support from the Government of Canada, provided through the Canadian International Development Agency (CIDA), the International Development Research Centre (IDRC) and Environment Canada, and from the Province of Manitoba. The Institute receives project funding from numerous governments inside and outside Canada, United Nations agencies, foundations and the private sector.

International Institute for Sustainable Development
161 Portage Avenue East, 6th Floor
Winnipeg, Manitoba
Canada R3B 0Y4
Tel: +1 (204) 958-7700
Fax: +1 (204) 958-7710
Email: info@iisd.ca
Website: www.iisd.org

Table of Contents

Executive Summary.....	1
1.0 The Lake Winnipeg Context and Water Quality Trading.....	4
2.0 Water Quality Trading: An overview	9
2.1 Trading systems	11
2.2 Trading entities.....	13
2.3 Market structures	15
2.4 Design elements.....	17
3.0 Water Quality Trading Case Studies.....	21
3.1 Grassland Area Farmers Tradable Loads Program, California	21
3.2 Minnesota River Basin Trading Program, Minnesota	24
3.3 Tar-Pamlico Nutrient Reduction Trading Program, North Carolina.....	26
3.4 Chesapeake Bay Watershed Nutrient Trading Program	29
3.5 Murray-Darling Basin Salinity Credit Scheme, Australia	31
3.6 Insights for the Lake Winnipeg Basin, Canada	34
4.0 Implementing Water Quality Trading in the Canadian Prairies	39
4.1 The regulatory basis	39
4.1.1 <i>The Canadian context</i>	39
4.1.2 <i>The American context</i>	43
4.2 Nutrient offset trading.....	45
4.3 Water quality predictions.....	46
4.4 Monitoring framework	47
4.4.1 <i>Compliance monitoring</i>	48
4.4.2 <i>Water quality monitoring</i>	48
4.4.3 <i>Watershed response monitoring</i>	48
4.5 Economic aspects	49
4.6 Challenges and barriers.....	51
5.0 Water Quality Trading for the Lake Winnipeg Basin: A Proposed Framework.....	54
5.1 The biophysical structure	55

5.1.1	Inter sub-basin trading.....	56
5.1.2	Intra sub-basin trading.....	58
5.2	The institutional structure.....	61
5.2.1	Federal/regional agencies.....	61
5.2.2	Provincial agencies.....	63
5.2.3	Watershed-level entities.....	64
5.3	The market structure.....	66
6.0	Conclusion and Recommendations.....	68
	Reference List.....	71
	Appendix A - Water Quality Trading Design Elements.....	82
A.1	Emission considerations.....	82
A.2	Ecological considerations.....	83
A.3	Legal and institutional considerations.....	85
A.4	Economic considerations.....	87
	Appendix B - Water Quality Prediction Techniques.....	89
B.1	Loading ratios.....	89
B.2	Simplified decision-making models.....	90
B.3	Simulation modelling.....	91
	Appendix C - Water Quality Measurement Parameters.....	95
C.1	Chemical parameters.....	95
C.2	Physical parameters.....	96
C.3	Biological parameters.....	96
	Appendix D - Valuing Ecosystem Goods and Services.....	98
	Appendix E - Water Quality Trading and Best Management Practices.....	101
	Appendix F - Manitoba Environmental Act Licenses.....	104
	Appendix G - The Trading Ratio Model.....	106

List of Figures

Figure 1:	The Lake Winnipeg Basin.....	4
Figure 2:	Phosphorus load ranges in tonnes/year flowing into Lake Winnipeg.....	6
Figure 3:	Water quality management process.....	9
Figure 4:	Emission credit purchasing options for permittee discharging above the regulatory cap	13
Figure 5:	Components for a WQT framework.....	18
Figure 6:	Map of the drainage area showing the San Luis Drain and the San Joaquin River.....	23
Figure 7:	The Minnesota River Basins covers 20 per cent of the State of Minnesota. The Minnesota River basin trading Program has been implemented in the majority of the Basin	25
Figure 8:	The Tar-Pamlico River Basin and its location within North Carolina.....	27
Figure 9:	The Chesapeake Bay watershed with sub-watershed and state divisions.....	29
Figure 10:	The Murray-Darling Basin showing the location of Morgan where the salinity level for the basin is monitored.....	32
Figure 11:	Estimated salinity levels without intervention and actual levels measured at Morgan located at approximately 200 km of the basin outflow	34
Figure 12:	The evolution of water quality legislation in the United States.....	43
Figure 13:	Conceptual representation of a multi-level trading system for the Lake Winnipeg Basin	55
Figure 14:	Lake Winnipeg watershed monitoring network and trading zones.....	56
Figure 15:	Conceptual representation of a multi-level trading system for the Lake Winnipeg Watershed	58
Figure 16:	Water quality monitoring locations administered by the Prairie Provinces Water Board	62

Figure 17:	The characteristics of the pollutant emissions and receiving medium will influence the ambient concentration of the pollutant in the water body	83
Figure 18:	Ambient based permit system.....	84
Figure 19:	Producer uptake of BMPs at various credit price levels in the Little Saskatchewan River watershed	102
Figure 20:	Wastewater treatment facilities in Manitoba.....	105
Figure 21:	The trading ratio model uses a zonal approach to design a water quality trading system	107

List of Tables

Table 1:	Phosphorus loading to area ratios from selected basins of the Lake Winnipeg Watershed	6
Table 2:	Synthesis of WQT market key features	17
Table 3:	General WQT System Design Elements.....	19
Table 4:	Water Quality Trading Systems Examined	35
Table 5:	Canadian legislation for the establishment of a WQT system	40
Table 6:	Potential roles of the agencies within the Lake Winnipeg Basin WQT system.....	65
Table 7:	South Nation Conservation phosphorous loading algorithms	89
Table 8:	Example of literature estimates of BMP effectiveness.....	90
Table 9:	Phosphorous abatement costs for BMPs in the Little Saskatchewan River watershed and for wastewater treatment.....	101
Table 10:	Public benefits from converting cropland to zero-till in the Tobacco Creek Watershed	103
Table 11:	Public benefits from converting cropland to permanent cover in the Tobacco Creek Watershed	103

Table 12:	Estimated cost in Canadian dollars of delivering water quality improvements in a Quebec watershed	103
Table 13:	Estimated cost in Canadian dollars of delivering water quality improvements in a Manitoba watershed	103

Executive Summary

Lake Winnipeg is an iconic feature on the Canadian Prairie landscape and its multi-jurisdictional basin covers the majority of Western Canada's agricultural zone. Although the lake is of regional and national importance, its water quality is being degraded and it is now the most eutrophied large lake in the world. Toxic blue-green algal blooms impacting the lake are driven by phosphorus loads. Industrial and municipal wastewater point sources, diffuse nonpoint sources from agricultural lands and natural background sources all contribute to the overall phosphorus load flowing into the lake. Effectively remediating the lake's water quality will require novel approaches that aim to lower water pollution from both point and nonpoint sources.

Agriculture is an important part of the economy and nonpoint phosphorus emission sources within the Lake Winnipeg Basin. A total of 100,816 farms across the basin covering approximately 47.16 million hectares of land equipped with farm capital valued at CDN\$112 billion participated in Statistics Canada's 2006 agricultural census (Agriculture and Agri-Food Canada, 2006). The agricultural sector provided employment in the basin as it generated CDN\$2.24 billion in net revenues in 2006 (Agriculture and Agri-Food Canada, 2006). It has greatly shaped the landscape and phosphorus emissions from agricultural operations contribute to the eutrophication of Lake Winnipeg. Enabling farming operations to thrive alongside healthy natural environments and water bodies is imperative for the long-term sustainability of the basin.

Water quality trading (WQT) is being touted as an ecologically and economically effective approach to improve water quality impaired from point and nonpoint sources. Initiated in the United States in 1981, WQT is now being applied in many parts of the world to cost-effectively reduce water pollution from point and nonpoint sources. For a WQT system to be effective in lowering both point and nonpoint sources, an adequate supply of nonpoint sources and sufficient demand from point sources is required. Ribaudo and Nickerson (2009) maintain that phosphorus trading between point and nonpoint sources is most likely within watersheds where the agricultural contributions to the overall phosphorus load ranges between 50 to 90 per cent (M. O. Ribaudo & Nickerson, 2009). Therefore, WQT can be effective at reducing emissions from point and nonpoint sources only within suitable supply-and-demand contexts.

Implementing a WQT system in the Lake Winnipeg Basin may provide an opportunity to harness the power of markets to cost-effectively lower phosphorus emissions. An estimate of the nonpoint and point source loads within the Canadian portion of the basin revealed that diffuse emissions from croplands range between 1,851 to 33,191 tonnes of phosphorus per year¹ while point source

¹ Cropland phosphorus emissions were estimated by multiplying emission coefficients (0.07 to 1.27 kg of phosphorus /year/hectare (Belcher, Edwards & Gray, 2001)) with total cropland area (26.14 million hectare).

emissions from industrial and municipal wastewater point sources range between 955 to 1,128 tonnes of phosphorus per year.² Based on these estimates, the agricultural contribution within the Canadian portion of the basin ranges from 59 to 97 per cent which fits into Ribaudo and Nickerson's (2009) favourable WQT point and nonpoint sources range. The point source contribution is likely greater, as the estimate was limited to large cities and municipalities participating in the 2006 Municipal Water and Wastewater Survey. Implementing a WQT framework within the Lake Winnipeg Basin will have to be carefully designed so that the supply and demand for water emission credits will lead to cost effective phosphorus reductions trading.

The International Institute for Sustainable Development, with the support of Agricultural and Agri-Food Canada (AAFC), examined the potential application of a WQT system within the Lake Winnipeg Basin to lower phosphorus emissions impacting the lake. The WQT architecture presented for the Lake Winnipeg Basin consists of a multi-level watershed-based trading system. Inter sub-basin trading would allow for meeting an overall phosphorus load target for the lake while intra sub-basin trading would allow for meeting phosphorus load targets at the sub-basin outflows. The multi-level architecture is designed to simultaneously remediate Lake Winnipeg's water quality and enable regional and local integrated water resources management.

Reverse Auctions could provide an effective way to initiate and manage intra sub-basin WQT where there is one buyer and multiple nonpoint sellers. Implementing reverse auctions can reveal the opportunity cost of nonpoint source BMPs, offering greater assurance that investments are least-cost. Reverse auctions can be structured to pursue multiple environmental objectives. For example, the reverse auction EcoTender program in Australia allowed for evaluating nonpoint BMP bids that simultaneously enhance biodiversity, rehabilitate aquatic functions, reduce salinity and sequester carbon. Using reverse auctions to facilitate intra sub-basin WQT could aim to cost effectively reduce nutrients and also reduce flooding, enhance wildlife habitats and sequester carbon.

The Canadian Environmental Protection Act and the Canada Water Act offer regulatory frameworks under which a WQT system could function. Environment Canada and AAFC's Agriculture Environment Services Branch are well suited to provide the institutional functions required to manage a WQT system (monitoring, verification and regulatory enforcement) within the basin. A composite market combining the characteristics of an exchange and clearinghouse structure is likely best suited for the Lake Winnipeg Basin as it can reduce transaction costs for individual sources.

² Point source phosphorus loads were estimated based on National Pollutant Release Inventory (Environment Canada, 2007) and Municipal Water and Wastewater Survey data (Environment Canada, 2006). Smaller point source phosphorus loads were estimated based on a methodology developed by Chambers et al. (2001).

The successful implementation of WQT within the Lake Winnipeg Basin will be highly dependent on the participation and the capacity of agricultural producers to lower nonpoint loads and supply cost-effective phosphorus offset credits via the adoption of best management practices (BMPs). Previous IISD work has examined the significant loss of ecosystem services within a portion of the Lake Winnipeg Basin over time and the potential for BMPs to produce multiple ecosystem service benefits (McCandless, Venema, Barg & Osborne, 2008; Voora & Venema, 2008).

Reducing nonpoint sources by implementing BMPs offers the possibility of realizing a number of co-benefits beyond improved water quality. For instance, restoring wetlands, riparian zones and buffer strips can improve water quality and provide wildlife habitat, mitigate floods and sequester carbon, and thus help adapt to climate change impacts. Although WQT will focus on cost effectively reducing nutrients within the basin, nutrient offset credits offering co-benefits could also be identified and potentially marketed. Similarly to the gold standard in carbon trading or environmental certification systems for agricultural goods, phosphorus offset credits with ecosystem service co-benefits could potentially command a premium value.

This research supports the implementation of section 17.1.4 (Supporting On-Farm Sustainable Agricultural Practices: Federal Priority BMPs) of the Growing Forward policy framework which aims to provide funding for producers to implement BMPs that protect water quality. The report provides WQT background information, design considerations, case studies and a general WQT architecture for the Lake Winnipeg Basin.

1.0 The Lake Winnipeg Context and Water Quality Trading

Lake Winnipeg is an iconic feature on the Canadian Prairie landscape and its basin covers the majority of Western Canada's agricultural zone. Although the lake is of regional and national importance, its water quality is being degraded and it is now the most eutrophied large lake in the world. Nutrient loads impacting the lake originate primarily from nonpoint sources across its vast multi-jurisdictional basin (see **Figure 1**). Effectively remediating the lake's water quality will require novel approaches that aim to lower water pollution from both point and nonpoint sources.

Lake Winnipeg drains an enormous inter-jurisdictional basin covering approximately 1 million km² and encompassing parts of Alberta, Saskatchewan, Manitoba, Ontario, North and South Dakota and Montana. Water flowing into and through Lake Winnipeg serves over six million people, passes through 55 million hectares of agricultural land and supports 17 million livestock (Roy, Venema, Barg & Osborne, 2007). The basin contains 90 per cent of the Canadian Prairies' agricultural land, sustaining a multi-billion dollar industry (Voora & Venema, 2008). The lake itself supports CDN\$20 million per year of commercial fishery, hydroelectricity production, livelihoods for aboriginal peoples and its shores are home to over 23,000 Manitobans (Lake Winnipeg Stewardship Board, 2006). Lake Winnipeg and its basin have significant regional and national socioeconomic importance.



Figure 1: The Lake Winnipeg Basin (Western Canada Wilderness Committee, 2008)

Lake Winnipeg is experiencing significant levels of blue green algal blooms driven by elevated nutrient concentrations (Roy, et al., 2007). Nutrient loads have increased by approximately 10 per cent over the last 30 years and urgent action is required to remediate the health of the Lake (Roy, et al., 2007). The nutrients that flow into Lake Winnipeg originate from human and animal sewage, chemical fertilizers, phosphate detergents and natural basin processes.³ Pollution sources are delivered to the lake either as point source discharges (wastewater treatment plants, industrial effluents) or diffuse nonpoint sources (atmospheric deposition, natural processes, agricultural runoff). The increased levels of eutrophication in the lake has led to reduced recreational appeal, degraded aquatic habitat, drinking water problems with taste and odour issues, clogged fishing nets and toxic algae (Armstrong, 2006). These problems have led to concerted efforts to monitor changes in nutrient loads over time and determine their points of origin.

While the types of nutrients affecting the lake are being debated, the data clearly indicates that the loads impacting Lake Winnipeg originate from a mix of point and nonpoint sources. Water quality monitoring data reveals that the Red, Assiniboine and Winnipeg Rivers flowing into the lake are nutrient-rich, corresponding to 73 per cent of total phosphorus and 52 per cent of total nitrogen loads (Lake Winnipeg Stewardship Board, 2006). The Souris and Saskatchewan River Basins also contribute significant amounts of nutrients impacting the lake (Lake Winnipeg Stewardship Board, 2006). Within Manitoba, watershed processes including natural background and undefined sources⁴ as well as agricultural activities comprise 67 per cent and 49 per cent of the provincial phosphorous and total nitrogen loadings respectively to Lake Winnipeg (Lake Winnipeg Stewardship Board, 2006). While loading ratios in other jurisdictions are less clear, based on consistency in landscapes and land use, we can assume they have broadly similar proportions. This indicates the need for policy instruments that effectively deal with both point and nonpoint nutrient sources.

The distribution of the annual phosphorus load per surface area flowing into Lake Winnipeg is shown in **Figure 2**. The phosphorus loading per surface area (tonnes/km²) of the Red, Assiniboine, Souris, Winnipeg and Saskatchewan River Basins are 2.3 times greater than that of the Lake Winnipeg Basin (see **Table 1** for more phosphorus loading per surface area ratios). The east and west sides of Lake Winnipeg and the areas surrounding Lakes Winnipegosis, Manitoba and Dauphin contribute very little phosphorus loads compared to the agricultural landscapes and residential areas to the south of the Lake Winnipeg Basin. These areas are either undeveloped or have low populations, which have kept their point and nonpoint water pollution sources low. A nitrogen load per surface area analysis would likely reveal similar results. Clearly, addressing the water quality of

³ Lake Winnipeg Stewardship Board report (2006) provides a synthesis of nutrient sources by jurisdiction and sector.

⁴ Natural background and undefined sources include forests, wildlife and septic fields (Lake Winnipeg Stewardship Board, 2006).

Lake Winnipeg will have to focus on addressing the nutrient loads originating from the highest contributors; the Red, Assiniboine, Winnipeg, Souris and Saskatchewan River Basins.

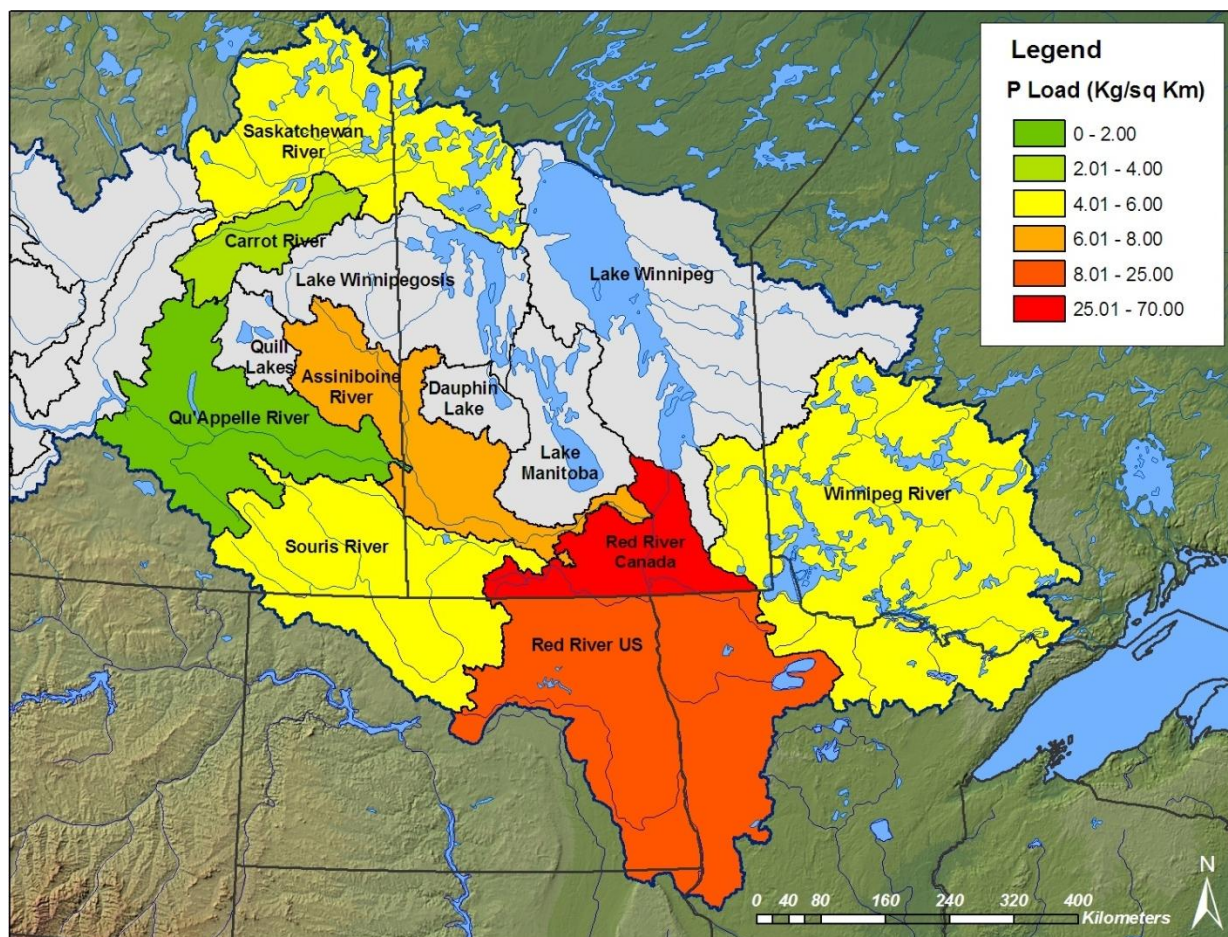

Figure 2: Phosphorus load ranges in tonnes/year flowing into Lake Winnipeg based on averaged total annual phosphorus loads measured from 1994 to 2001 at long-term monitoring stations in Manitoba and interpreted by Bourne et al. (2002)

Table 1: Phosphorus loading to area ratios from selected basins of the Lake Winnipeg Watershed

Basin	Area in km ²	Phosphorus load in tonnes	Phosphorus kg/km ²	Sub-basin to basin Phosphorus load ratio
Red River - Canada	25,106.02	1,734	69.06	11.71
Red River - United States	101,709.27	2,537	24.94	4.22
Assiniboine River	41,533	330	7.9	1.35
Saskatchewan River	66,870	307	4.6	0.78
Souris River	62,484	307	4.9	0.83
Winnipeg River	136,927	788	5.8	0.97
Lake Winnipeg Basin	1,026,929	6,065	5.9	1.00

Although some basins contribute more or less nutrients to the overall nutrient load of the lake, opportunities exist across its basin to minimize water pollution from point and nonpoint sources and its related impacts on the lake. Coordinating efforts and resources to improve Lake Winnipeg's water quality by lowering water pollution originating from point and nonpoint sources is imperative to remediate it in a timely and cost-effective manner.

In the Lake Winnipeg Basin context, the largest sources of nutrients are widespread, nonpoint sources, and therefore command and control regulation would imply broad-based enforcement. Attempts at such large-scale behavioural change would benefit from the incentives/disincentives that market-based instruments offer. The context of the Lake Winnipeg Basin, with a large proportion of nonpoint agricultural nutrient loads, makes it amenable for the implementation of a water quality trading (WQT) framework. Within a WQT framework, the supply of water emission credits from nonpoint sources needs to be balanced with demand from point sources. A well designed WQT system for the Lake Winnipeg Basin could potentially lead to cost-effective nutrient load reductions impacting its water bodies.

The Lake Winnipeg Basin faces complex water quality issues primarily driven by nonpoint sources, making it harder to manage and monitor (Lake Winnipeg Stewardship Board, 2006). A key element of mitigating nonpoint source emissions, particularly from agricultural sources is through the use of best management practices (BMPs).⁵ BMPs can be actions taken by agricultural producers and land managers to minimize negative impacts to the environment while maintaining or improving the quality of water, soil, air and biodiversity (Lake Winnipeg Stewardship Board, 2006). BMPs have enabled farmers and land managers to better steward their land and water without compromising productivity or income.

The Lake Winnipeg Stewardship Board report (2006) makes the case for the use of BMPs in nutrient management, citing previous research that emphasizes their use for reducing nutrient losses from croplands and from lands sustaining livestock (B. Chambers, Garwood & Unwin, 2000; Sharpley, Foy & Withers, 2000). They recommend additional research to determine the benefits of specific BMPs in the Lake Winnipeg Basin context.

Water quality trading is being touted as an ecologically and economically effective approach to improve water quality within watersheds. It is implemented so that resources can be spent cost effectively to lower water pollution from point as well as nonpoint sources. The first WQT program was initiated in the United States in 1981. Since then, a number of WQT programs have emerged

⁵ Agricultural BMPs include practices such as the establishment of riparian vegetation, grassed waterways, conservation tillage, variable rate fertilization, constructed wetlands, shelterbelts and alternate animal feeding strategies, etc. Non-agricultural BMPs may include urban riparian buffers, green developments, urban landscape management, water table recharge systems, etc.

internationally. WQT could provide a coordinated approach to improve the Lake Winnipeg's water quality that is both ecologically and economically effective.

For a WQT system to be effective in lowering both point and nonpoint sources, an adequate supply of nonpoint sources and sufficient demand from point sources is required. Ribaudo and Nickerson (2009) maintain that phosphorus trading between point and nonpoint sources is most likely within watersheds where the agricultural contributions to the overall phosphorus load ranges between 50 to 90 per cent. Therefore, WQT can be effective at reducing emissions from point and nonpoint sources only within suitable supply and demand contexts.

Implementing a WQT framework within the Lake Winnipeg Basin will have to be carefully designed so that the supply and demand for water emission credits will lead to cost-effective phosphorus-reductions trading. An estimate of the nonpoint and point source loads within the Canadian portion of the basin revealed that diffuse emissions from croplands range between 1,851 to 33,191 tonnes of phosphorus per year,⁶ while point source emissions from industrial and municipal wastewater point sources range between 955 to 1,128 tonnes of phosphorus per year.⁷ Based on these estimates, the agricultural contribution within the Canadian portion of the basin ranges from 59 to 97 per cent, which fits into Ribaudo and Nickerson's (2009) favourable WQT point and nonpoint sources range. The point source contribution is likely greater as the estimate was limited to large cities and municipalities participating in the 2006 Municipal Water and Wastewater Survey.

The International Institute for Sustainable Development, with the support of Agriculture and Agri-Food Canada (AAFC), are exploring WQT programs to provide some design considerations for its implementation within the Lake Winnipeg Basin. WQT features and design considerations are examined. Case studies are investigated to identify their key features and provide guidance for the establishment of a WQT program for the Lake Winnipeg Basin. Specific WQT design considerations for its potential application within the Canadian Prairies are described to set the stage for developing a Lake Winnipeg Basin WQT program design.

The report describes the technical and institutional features, relevant analytical and decision-making tools, as well as a generic systems model required to establish watershed based WQT programs within large basins. The application of a WQT program within the Lake Winnipeg Basin is then examined by identifying key point and nonpoint sources and institutional entities responsible for nutrient management and recommending design features for a WQT program for the basin.

⁶ Cropland phosphorus emissions were estimated by multiplying emission coefficients (0.07 to 1.27 kg of phosphorus /year/hectare (Belcher, et al., 2001)) with total cropland area (26.14 million hectare).

⁷ Point source phosphorus loads were estimated based on National Pollutant Release Inventory (Environment Canada, 2007) and Municipal Water and Wastewater Survey data (Environment Canada, 2006). Smaller point source phosphorus loads were estimated based on a methodology developed by Chambers et al. (2001).

2.0 Water Quality Trading: An overview

Water quality has typically been managed using a regulatory approach, which has been effective for addressing pollution loads originating from point sources (see **Figure 3**). Nevertheless, regulation can be expensive as dischargers cannot take advantage of marginal abatement cost variances between point and nonpoint sources. In addition, regulation is relatively ineffective for dealing with nonpoint sources as they are diffuse, difficult to monitor and it is difficult to discern how they are entering waterways (Pharino, 2007). Pharino (2007) states that water treatment efficiency is becoming increasingly important due the following trends:

- Escalating impacts from nonpoint sources
- Stricter regulations for water quality
- Rising abatement costs
- Increasing use of chemicals and energy
- Growing replacement costs of aging and failing water infrastructure.

Carefully assessing water quality management options to determine their effectiveness in achieving desired water quality goals is becoming increasingly important.

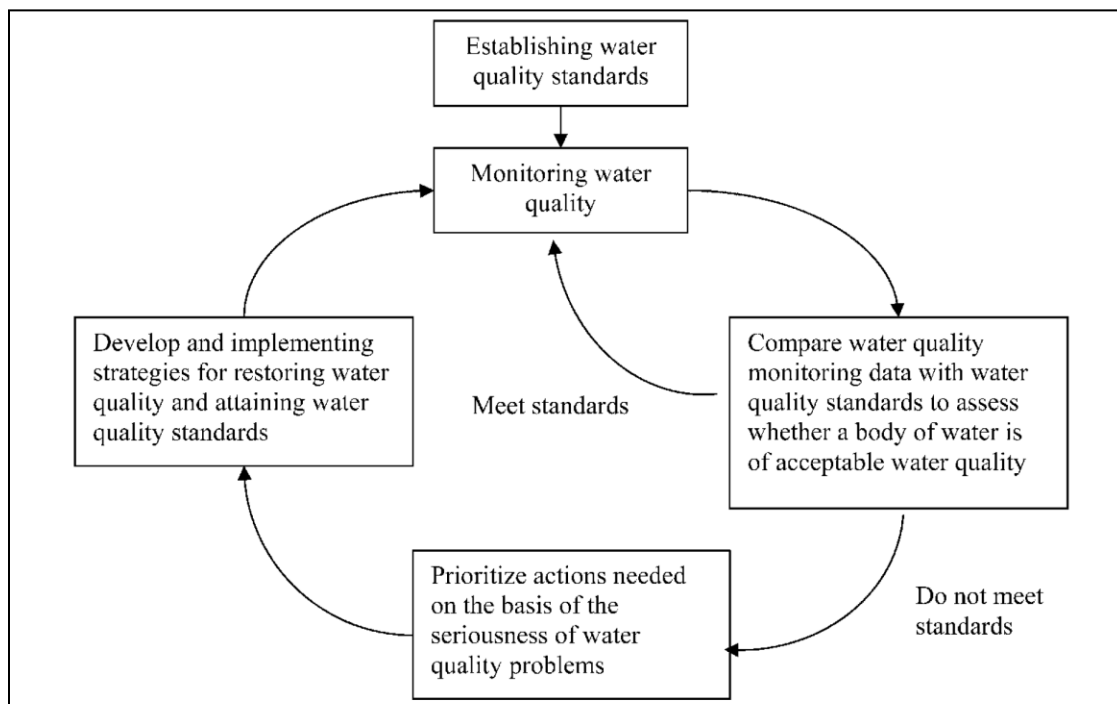

Figure 3: Water quality management process (Pharino, 2007, p. 11)

WQT is a market-based complement to command and control policies for meeting water quality goals (M. O. Ribaud & Nickerson, 2009). A WQT program requires a market where water effluent trades can occur. A pollution-control authority sets an overall limit and allocations to pollution sources such that the limit is not violated. The polluting entities can then trade amongst themselves to meet the overall limit in the most effective manner. Concretely, this means that a facility facing high pollution control costs can purchase equivalent reduction requirements from other sources at lower costs.

A key argument for using WQT programs over traditional regulatory approaches has been its relative cost effectiveness (Pharino, 2007). Even though the regulatory approach has proved to be effective for addressing pollution loads from point sources, it is typically a costly option as all point sources must meet a standard regardless of abatement costs. WQT allows for the collective resources of the polluting entities to be spent in the most cost effective manner to meet the standards. Pharino (2007) reports that 470 large point-source emitters in the United States could save between US\$611 million and US\$5.6 billion if they were allowed to purchase nutrient reductions from nonpoint sources.

In addition to being potentially cost effective, WQT can be an ecologically effective complement to the command and control regulatory approach (Nguyen, Woodward, Matlock, Denzer & Selman, 2006). Nonpoint sources impairing water quality cannot be easily regulated, as they are difficult to monitor and often cannot be linked to a particular party. In addition, they can dramatically increase due to random events. WQT can also potentially support conservation practices that improve soil, water and air, and raise land values and farm income, which are imperative for improving health and well-being. The flexibility provided by WQT to achieve an environmental goal often leads to a number of additional ecological and social benefits. Consequently, WQT can be a nice complement to traditional command and control approaches.

Ribaud and Nickerson (2009) discuss the inclusion of nonpoint sources in WQT programs in the U.S. and assess their potential to provide farmers with financial incentives for improving water quality by reducing nutrient loads. They determined that hydrologic units where agricultural nonpoint sources accounted for 50 to 90 per cent of the nutrient loads were ideal for point to nonpoint source WQT programs. This range provided enough supply from agricultural nonpoint sources and demand from point sources to potentially reduce a significant amount of agricultural water pollution (they used an impact trading ratio⁸ not lower than 2[nonpoint source]: 1[point

⁸ An impact trading ratio is the number of pollution reduction units a source must purchase as a credit to offset one unit load of discharge/emission. For instance, a 2:1 trading ratio indicates that source 1 must decrease its emissions by 2 units if source 2 increases its emissions by one unit. Trading ratios are usually implemented to address fungibility considerations and abatement uncertainties.

source]). They concluded that establishing a market in a water quality-impaired watershed with regulated emitters could result in conservation funds targeted to farmers that can provide cost-effective water quality improvements. They argue that if point sources pay for reducing agricultural water quality impairments, conservations programs could focus their limited budgets on other issues. Farmers would also benefit from an additional source of income.

Economic approaches such as WQT have had some success in water quality management efforts across the world.⁹ If integrated with appropriate capacity and designed to be consistent with the principles of integrated water resources management (IWRM),¹⁰ WQT can prove beneficial not only for water quality improvement, but also for realizing co-benefits such as improved agricultural practices through the adoption of beneficial management practices, improved local and institutional capacity for ecosystem-based management, improved synergistic programming and cost effectiveness. This multi-pronged approach is consistent with an increasing acceptance of the fact that using a variety of policies to address the same issue increases the likelihood of achieving desired outcomes (Nair & Roy, 2009). This is based on the understanding that “many interventions will fail and that such failures are simply a feature of how one develops successful interventions in complex adaptive systems” (Glouberman, et al., 2006). Using a variety of policy instruments also takes into account social, environmental and economic improvements and is consistent with the principles of sustainable development. For these reasons, their resourcing and development must be prioritized over single outcome programs with narrow scopes.

2.1 Trading systems

There are essentially two types of trading systems: **closed systems**, also called “cap-and-trade,” and **open systems** also called “credit or offset” (Sauve, Nolet, Whyte & Sanchez, 2006). Closed trading systems rely on the government’s enforcement of an absolute cap for all sources covered by the program, which is chosen to achieve a specific environmental objective such as lowering the eutrophication of the Lake Winnipeg. Discharge allocations that can be traded are given to participating sources and total emissions cannot exceed the regulated cap. In open systems, tradable credits are provided to facilities that reduce their emissions below a regulated baseline. The tradable credits can then be sold to facilities facing elevated costs or difficulties in meeting their regulatory requirements. These systems are being used in combination to achieve cost-effective nutrient load reductions.

⁹ Examples of successful WQT initiatives include the North Carolina Tar-Pamlico in the United States, South Nation Phosphorus Trading program in Canada and the Murray-Darling Basin Salinity Credit Trading Scheme in Australia.

¹⁰“IWRM integrates land use and water management at a watershed level, to optimize economic, social and environmental outcomes simultaneously” (Policy Research Initiative, 2004, pp. 1-2).

Trading can occur between point sources or involve nonpoint sources. Limiting WQT between point sources simplifies the transactions but including nonpoint sources increases the range of marginal abatement costs, which stimulate trades due to cost effectiveness of such offsets. Shabman and Stephenson (2007) point to the need for creativity in including nonpoint sources within WQT systems as they are difficult and costly to measure, monitor and enforce. Nonpoint sources are typically unregulated and often comprise the largest source of nutrient loads - occurring through sporadic, small, individual contributions. However, abatement costs can be substantially less than for point sources for which additional regulation will be “expensive and fruitless” (Roberts, Clark, Park & English, 2008). Options for incorporating nonpoint sources within WQT systems include (Shabman & Stephenson, 2007):

1. Integrating nonpoint sources within the allowance cap by bringing these sources under mandatory mass loading reductions; and
2. Establishing actual nonpoint source “credit” trading outside of the cap where dischargers can purchase credits to meet discharge limits

In a WQT system, where trading between point and nonpoint sources is permitted, emission credits can be acquired in a number of ways (see **Figure 4**). Faced with the challenge of reducing pollutant emissions to meet a regulatory cap, a permittee can:

- A. Buy “credits” to offset his excess beyond the regulatory cap by:
 1. Approaching a seller of emission credits and negotiating the best price;
 2. Seeking a nutrient credit broker to buy credits and pay a fee for his services;
 3. Approaching an exchange market that tracks buyers, sellers, and prices so that the buyers can get the best value for their credit purchases.
- B. Make internal technological and structural changes and investments to lower emissions.

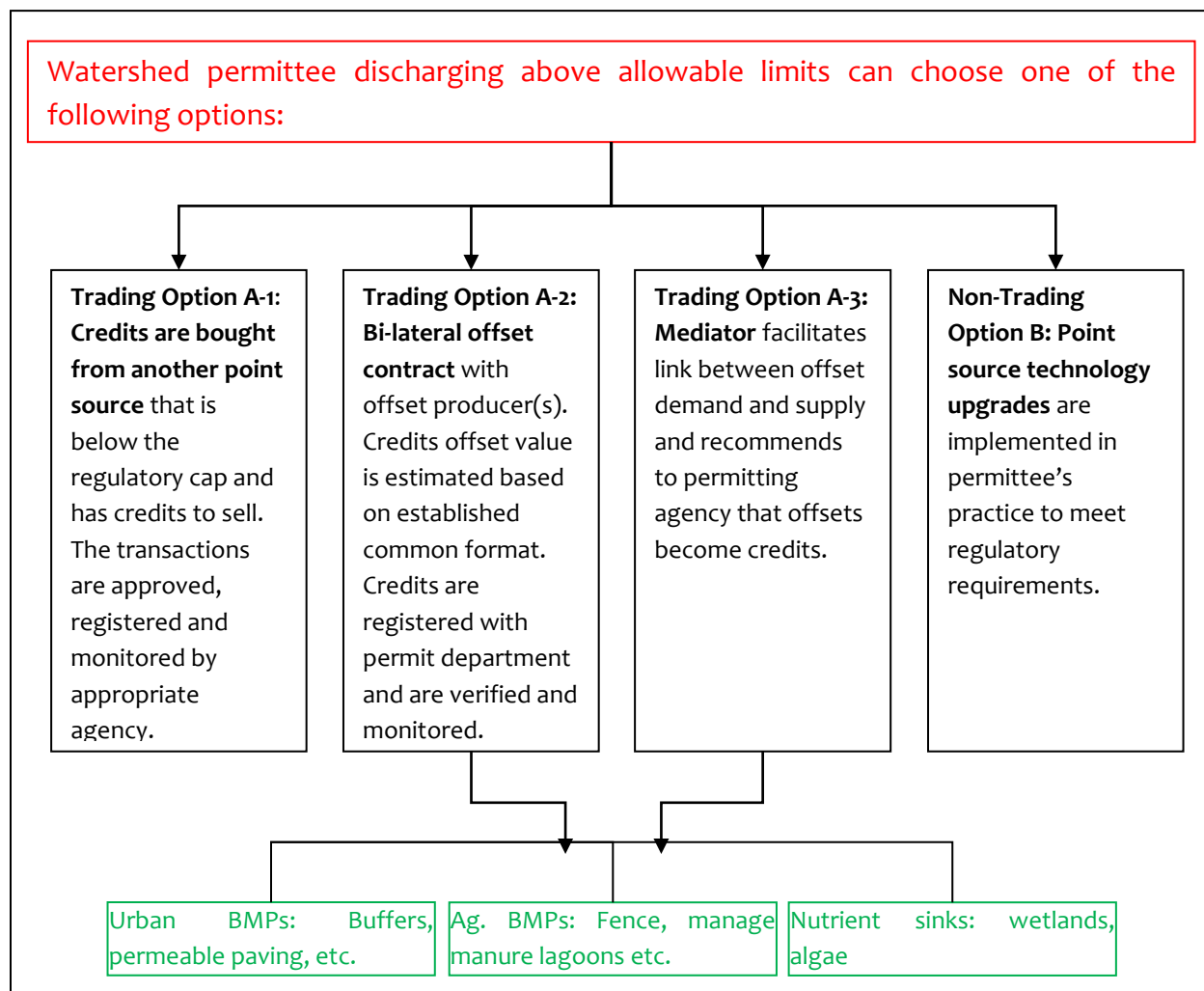

Figure 4: Emission credit purchasing options for permittee discharging above the regulatory cap

2.2 Trading entities

WQT typically involves a variety of entities or stakeholders including agricultural producers; industrial and municipal facilities; government agencies at the federal, provincial and local levels; nongovernmental organizations; and relevant community and civil society groups. The roles of these stakeholders depend largely on the structure and functionality of the market. The success of WQT system implementation is closely linked with the level of acceptance and participation of these entities. A brief discussion of the roles found in a typical WQT system is described below:

Buyers and sellers are simply the regulated point sources of emissions and the unregulated nonpoint sources that are the actual buyers and sellers of credits or offsets under a WQT system.

The effectiveness of a WQT framework hinges on the ability of buyers and sellers to be successful, either in terms of least cost mitigation options for regulatory obligations, or income support from the sale of credits. This ability of buyers and sellers to be successful can depend on the presence of an adequate number of identified pollution sources within a given watershed trading area - above which a “receptor,” or monitoring location exists (Roberts, et al., 2008). Many apparent WQT markets contain only a small number of potential market participants. Despite the fact that 39 per cent of all assessed streams in the U.S. are impaired, the problem of “thin” markets has been identified in Tennessee, where more than 70 per cent of identified watersheds were deemed to contain too few point source emitters to support effective trading (Roberts, et al., 2008).

Agricultural producers often play the role of sellers in WQT because they typically implement conservation practices that generate pollutant reductions that can be bought by permitted facilities. The term *buyer* is often used to describe the role of permitted facilities that need to “buy” pollution credits to fulfill their permitted levels of discharge. Buyers may include industrial and municipal permittees, as well as large agricultural operations such as hog farms that may need permits to manage their waste.

According to the U.S. Environmental Protection Agency (U.S. EPA) guide to WQT, a permittee can be either a buyer or a seller of pollutant credits. The permittee’s primary responsibility is compliance with the provisions of the National Pollution Discharge Elimination System permit. Beyond basic compliance, other potential roles for the permittees could include being a source of information for developing trade agreement provisions and appropriate permit conditions. Some WQT systems might also employ producers to perform trade verification activities, such as conservation practice inspections for other producers. Although this could potentially lead to collusion among the producers, their active involvement in the various aspects of the WQT system is imperative for it to be successful.

Trading policy makers and/or regulators include government or other permitting agencies that establish broad guidance for trading, including specific policies as necessary. Depending on the structure and rigor, the trading policy-makers establish necessary regulations, guidance documents and other tools to assist those interested in trading.

According to Stephenson et al. (1999) the regulator in an allowance market serves as the market designer who creates the condition for decentralized decision-making and who monitors and enforces the rules concerning wastewater disposal. Due to the complex and overlapping nature of responsibilities, WQT systems need cooperation among federal, state and local efforts.

Young and Karkoski (2000) suggest that regulators may need to redefine nonpoint sources as a collection of small, independent, and controllable sources rather than diffuse, uncontrollable, and

unmonitored sources, or define it based on capacity of operations/types of firms or size of activity to be able to assign their responsibilities.

Credit exchanges are third parties that facilitate the exchange of credits between buyers and sellers. There are several variations of credit exchanges, including brokers, aggregators and central exchanges. Agencies that can fulfill this role often include state agencies, local conservation authorities, nongovernmental organizations, private industry or individual entrepreneurs.

Financial and technical service providers offer the required financing and technical expertise to establish and operate a WQT system. Many existing trading systems rely on public and private financing to cover initial start-up and operating costs. In addition, trading systems often rely on credible sources of technical information related to conservation practice implementation and verification, economic analysis and watershed management.

Verification and monitoring officials ensure that water quality outcomes are met through the WQT system. The role of verifier is often tied to the water quality monitoring function, but might simply be restricted to verification of conservation actions by buyers and sellers. This role may also involve verifying trade conditions and transactions.

2.3 Market structures

Woodward et al. (2002) defines market structures as being the “standards for obtaining information and exchanging rights” (968). Specifically, Williamson (1985) claims that structures are distinguished by two factors: the extent to which information regarding the good is publicly visible, and whether the transaction relationships are discrete, terminating when the contract performance is complete, or relational, persisting over time.

WQT between point and nonpoint pollutant sources is based on the creation of a market where pollution emissions are limited. Market dynamics and tradable permits are used to stimulate negotiations among emitters to minimize costs. The actual trading between buyers and sellers in a watershed for water quality objectives can occur in a number of different ways. As in other traditional financial markets, individuals or institutions can interact directly with each other to buy and sell transferable commodities, use intermediaries as brokers or agents, or use established markets with predetermined rules and structures. There are four main WQT market structures, which are described below:

- i. **Bilateral negotiations:** These markets typically entail substantial interaction between buyer and seller to exchange information and negotiate terms of trade. This kind of trading is typically for commodities that are fairly unique in terms of price and quality. Contracting and

enforcement costs are higher in bilateral negotiations; however this structure has the ability to accommodate non-uniform goods that could not be traded through an exchange. Bilateral negotiations form a large proportion of trades in the U.S., demonstrating that perhaps the uniformity necessary for an exchange is often more costly than the transaction costs that follow from this structure. Bilateral trading is well-suited to WQT markets because it can accommodate the need to exchange detailed information about each credit and allows for negotiating the terms of monitoring over time that is required under buyer liability.

- ii. **Water quality clearinghouses:** A clearinghouse market structure is one in which the link between buyer and seller is completely broken by an intermediary. In the context of WQT, a clearinghouse can be an entity authorized by the oversight agency to pay for pollution reductions and then sell credits to sources needing to exceed their allowable loads. A clearinghouse differs even from the presence of a broker in a bilateral negotiation in that it eliminates all contractual or regulatory links between sellers and buyers. A clearinghouse must be mandated by law and permitted under the WQT system. These laws must authorize an agency to play this role - to denominate credits on the basis of reductions obtained, and resell those credits to interested buyers. Since the benefit of a clearinghouse is its ability to create a uniform good for final sale, this structure is not well-suited to situations in which the law requires final buyer liability for pollution reduction. Transaction costs are lower in this structure because: a) it reduces the search and information costs, since both purchasers and sellers interact with only one party; b) credits are known to be acceptable to regulators; c) if the selling party is publicly visible and standardized practices for trading are clear, bargaining and negotiation costs would also be reduced. A clearinghouse is suited to WQT between point and nonpoint sources of nutrients.
- iii. **Exchange markets:** Exchanges, most popularly known by the stock exchange markets, are the most idealized version of a market. Prominent characteristics of this market structure are the open information structure and fluid transactions between buyers and sellers. Information regarding prices being offered and asked is publicly available and products being traded are relatively uniform. Information regarding buyers' and sellers' interests is easily transmitted, and transactions are easily consummated.
- iv. **Sole-source offset:** This structure isn't really a market structure and does not involve trading at all. Sole source offsets in WQT take place if a source is allowed to meet a water quality standard at one point if pollution is reduced elsewhere, either on-site or by carrying out pollution reduction activities off-site. Legal foundations for sole source appear to be more easily satisfied than for any other market structure. Since there is only one party involved, the responsibility for achieving the necessary offsets remains with the single source, eliminating the need to define the property right that is implicit in the other market

structures. Sole source offsets cost less than other structure, since there are no formal transactions. From a regulator's perspective, sole-source offsets internalize management and facilitate enforcement relative to other structures since this approach does not introduce any additional parties into the equation.

A market structure will evolve over time if presented with the opportunity to allow the sharing of information and/or the completion of transactions at a lower cost. Authorization, monitoring and enforcement choices made during system design can affect these structures by generating transaction costs. See **Table 2** for the key features of WQT markets.

Table 2: Synthesis of WQT market key features (Woodward, Kaiser & Wicks, 2002)

Market	Exchange	Clearinghouse	Bilateral negotiations	Sole-source offsets
Indicators of market efficiency				
Transaction costs per trade	Lowest	Low	Highest	NA
Initial set-up costs	High	High	Low	Lowest
Indicators of ability to ensure environmental efficacy				
Degree of uniformity required	Highest	High	Low	Lowest
Buyer liability a possibility	No	No, but clearinghouse can assume liability	Yes	NA

Composite markets have evolved out of the market structures presented above and are described by Collentine (2005) as being three interrelated markets, each serving a particular function. The two primary markets are coordinated through price information, which makes it possible for a catchment authority to issue (sell) permits based on the marginal cost of abatement. When the composite market is mature, the total number of permits issued corresponds to a cap on discharges allowed in the catchment. The structure of the composite market allows this system to be phased in over time with existing institutions and limited demands on financing. A combination of these market structures is a potential option and the composite market structure is discussed in some detail as a potential solution in the Lake Winnipeg Basin in a later section of this document.

2.4 Design elements

The general design and management elements of a WQT system are presented by examining its emission, environmental, legal and institutional and economic considerations. To ensure ecological

effectiveness, the geographical scope of a WQT system must be at the watershed or basin scale.¹¹ They are ideally suited for implementing WQT systems due to the interconnected nature of their landscape and water resources (Sauve, et al., 2006).

Setting up a WQT system requires water quality goals, trading mechanisms, knowledge of treatment costs, compliance rules and monitoring and enforcement (Pharino, 2007). The general design and suitability of a WQT system is dictated by the pollutant's characteristics (toxicity, breakdown and interdependencies), transport mechanisms (point and nonpoint sources) and receiving medium (characteristics of the water bodies). In addition, the environmental, legal and institutional and economic dimensions need to be considered. The elements shown in **Figure 5** are introduced in **Table 3** (see **Appendix A** for more details).



Figure 5: Components for a WQT framework

¹¹ According to Schreier et al., of the Institute for Resources and Environment at the University of British Columbia, a watershed or a basin is “an area of land, bounded by topographic features that drains water to a shared destination such as a lake, stream, estuary, or ocean. A watershed captures precipitation, filters and stores water and determines its release” (Ewaschuk, 2005).

Table 3: General WQT System Design Elements

Emission Considerations	
Pollutant characteristics	The nature of the pollutant (toxicity, breakdown and mixing) dictates if it is suitable for trading.
Transport mechanism	Point sources (direct or indirect discharge) are defined localized emission sources to water bodies. Nonpoint sources are diffuse sources that are difficult to monitor but often less costly to mitigate.
Receiving medium	Background pollution levels, hydromorphology and aquatic biology will impact pollution dispersion assimilation and its ambient concentration.
Modelling	Modeling provides a means to assess pollutant transport and assimilation required to set adequate caps and allocate permits.
Environment Considerations	
Geographical scope	WQT is more ecologically effective when it is based on watersheds as opposed to institutional boundaries
Ecological objectives	Setting ecological objectives for receiving water bodies instead of flowing streams and rivers can capture cumulative impacts.
Upstream/downstream dynamics	The upstream-downstream dynamic of the pollution sources will influence the pollution concentration at various points within the watershed.
Emission- and ambient-based permits	Emission-based permits focus on allowable pollution levels at the source. Ambient-based permits link emissions to pollution levels within water bodies.
Trading ratios	Impact trading ratios are set exogenously or endogenously to maintain the permit homogeneity. Uncertainty trading ratios are applied to nonpoint sources to minimize risks and ensure ecological effectiveness.
Legal and Institutional Considerations	
Government responsibility	A shift is required from regulator to market designer and trading rules enforcer.
Permit allocations	Auctions or grandfathering can be used to allocate permits to emitters participating in the WQT system.
Monitoring and enforcement	Monitoring and enforcement is required to ensure that the WQT system is improving water quality and that trading rules are being respected.
Sanctions for non-compliance	Penalties, which can range from notifications to fines and criminal charges, need to be in place to encourage compliance with trading rules.
Economic Considerations	
Trade and market type	WQT allows for Point-to-Point, Point-to-Nonpoint and Nonpoint-to-Nonpoint source trading. Market types include bilateral, third party broker, clearinghouses and exchanges.
Cost effectiveness	A wide range of marginal abatement costs is required to achieve cost effectiveness defined as achieving an ecological objective at least costs. This may be difficult to achieve if the market is “thin” or if there is not the right supply and demand balance for water discharge credits.

Transaction costs	Transaction costs are greatly influenced by the nature of the water discharge credit that is being traded. High transaction costs can stifle trading activity and they originate from market structures, government oversight, monitoring and enforcement.
Dynamic efficiency	Advances in abatement technologies must be considered so that innovation will not be hampered.
Market distortions	WQT systems must be designed to avoid market power, price fixing, intended pollution inflation and free riding.

3.0 Water Quality Trading Case Studies

Five WQT case studies were examined to identify features that could inform the development of a similar system for the Lake Winnipeg Basin. Developing and implementing WQT systems have, in general, led to water quality improvements by providing jurisdictions with a flexible mechanism to improve water quality. Some WQT systems have had some success in enhancing water quality through trading activities while others have yet to start.

The Grassland Drainage Area is the only example of nonpoint-to-nonpoint source trading in the United States. The Minnesota Pollution Control Agency has developed the Minnesota River Basin Trading Program and two offset programs in the Minnesota River Basin to lower nutrient loads originating primarily from agricultural runoff. The Tar-Pamlico Nutrient Reduction Program in North Carolina has successfully lowered nutrient concentrations in its watershed without trading activity. Interstate and state WQT within the Chesapeake Bay watershed provide insights for developing programs within multi-jurisdictional watersheds. The Murray-Darling Salinity Credit Scheme, developed to lower salinity concentrations, was examined due its comparable size and similar multi-jurisdictional nature with the Lake Winnipeg watershed.

3.1 Grassland Area Farmers Tradable Loads Program, California

Located in the San Joaquin watershed, which drains into the California River Basin, the Grassland Area Farmers Tradable Loads Program was initiated to lower selenium concentrations in drainage water from an agricultural landscape covering approximately 1500 km². The land in the area is tiled and drained to avoid crop damage. The drainage water has high naturally occurring selenium concentrations and is pumped into the San Luis Drain, which empties in the Kesterson Reservoir. Increased selenium concentrations in the reservoir were found to be causing wildlife deaths and deformities. To continue using the San Luis Drain, stringent water quality standards were imposed. The Grassland Area Farmers in the San Joaquin Valley responded by establishing a consortium of seven irrigation and drainage districts to administer a selenium cap and trade program. The program has enabled the farmers to cost effectively and equitably meet the newly imposed selenium discharge limits (Breetz, et al., 2004).

A number of agencies were involved directly and indirectly in shaping the Grassland Area Farmers Tradable Loads Program. The Grassland Area Farmers became a legal entity with the right to establish selenium load allocations and enforce discharge requirements for each participating district. The Environment Defense Fund and the Economic Incentives Advisory Committee helped initiate and design the tradable loads program. The San Luis Delta-Mendota Authority signed the San Luis Drain use agreement with the U.S. Bureau of Reclamation who controls and monitors the San Luis

Drain and establishes a selenium cap for its effluent. The California Regional Water Quality Control Board - Central Valley Region established discharge regulations for the bypass project.

The program was launched in 1998 and was considered to be the first nonpoint-to-nonpoint WQT program in the United States. However, it can be viewed as a point-to-point system, as selenium concentrations are measured monthly at 62 drainage pump locations (Breetz, et al., 2004). Flow measurements and water samples are acquired from the monitored sumps, which can take several months to analyze. For this reason, all trades are retroactive. The final effluent of the San Luis Drain is monitored by the U.S. Bureau of Reclamation using automated stations. The trading ratio is 1:1 because there is a single overall discharge point and the effluent sump water quality is closely monitored.

An overall district cap is established based on the total maximum daily load (TMDL)¹² set by the U.S. EPA for the lower San Joaquin River. Each district is allocated a portion of the overall district selenium cap based on district characteristics such as tilled acreage, total acreage and historical selenium loads. Districts are responsible for implementing programs such as water pricing and recycling drainage water to meet their targets. Fines are applied if the aggregate cap is not respected and the use of the drain is cut if the target is exceeded by 20 per cent (Breetz, et al., 2004). Fine impositions are waived if natural circumstances such as unusually high rainfall events are responsible for excessive selenium concentrations. A rebate fine system was implemented in 1999 where districts exceeding their caps pay fines which are distributed as rebates to the districts that meet their caps, thus providing additional incentives for districts to meet their targets.

The trading program has been largely successful but is no longer active. Thirty nine trades valued at \$14,320 have led to a 61 per cent decrease (from 9,600 to 3,700 lbs) in selenium emissions since the inception of the program in June 1998 (U.S. Department of the Interior - Mid-Pacific Region, 2005). Transaction costs were kept to a minimum due to the open working relationship amongst the districts who met once a month to coordinate trades. Trading was more or less discontinued in 2000 as one district implemented a drainage recycling program that significantly lowered the regional selenium load (Breetz, et al., 2004).

Key features...

- Only nonpoint-to-nonpoint water quality trading program in the United States.
- Selenium concentrations are monitored at 62 drainage pump locations.
- Trading occurred during monthly meetings and is retroactive based on monitoring results.
- Fine impositions are waived due to outstanding natural circumstances (excessive rainfall).
- Irrigation districts act as credit aggregators
- Nonpoint sources are treated as point sources at their watershed outlets.

¹² Total maximum daily loads (TMDLs) are the amount of pollutants a given water body can sustain without violating prescribed water quality limits (Feldman, 2007).

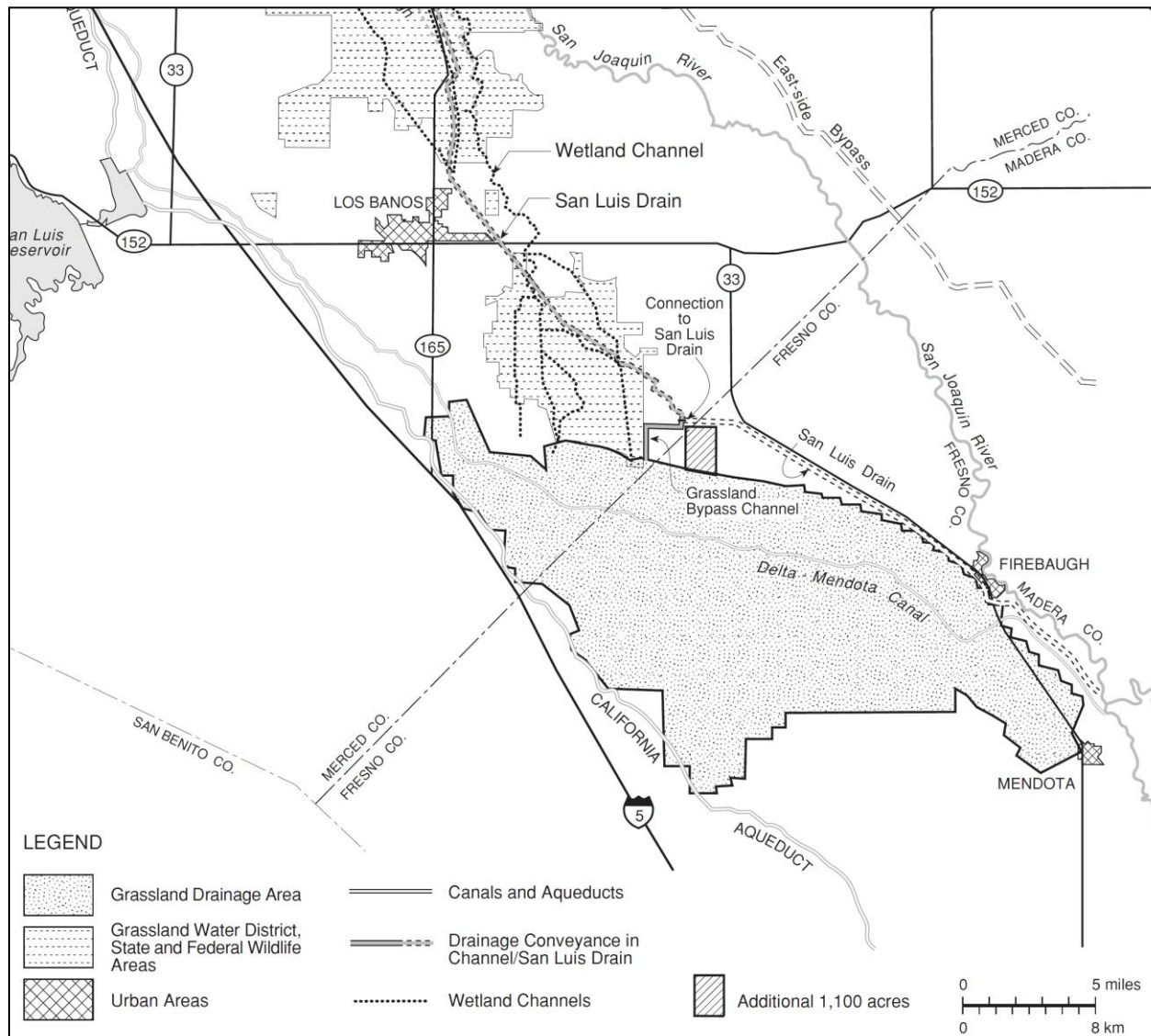

Figure 6: Map of the drainage area showing the San Luis Drain and the San Joaquin River (U.S. Department of the Interior - Mid-Pacific Region, 2005)

Unofficial rules continue to be written annually, as it is believed that WQT may be of importance in the future to meet more stringent regulations. One of the indirect benefits of the program was the removal of 93 miles of drainage channels, which led to increased freshwater flows to wetlands (Breetz, et al., 2004). Breetz, et al. (2004) believe that the program could be enhanced by involving individual farmers and setting the market at the farm level instead of the district level.

3.2 Minnesota River Basin Trading Program, Minnesota

The Minnesota River Basin drains 43,434 km², corresponding to approximately 20 per cent of the State of Minnesota (Minnesota Pollution Control Agency, 2007a). Agricultural activity accounts for 92 per cent of the land use in the basin (Minnesota River Basin Data Center, 2003). The lower reaches of the Minnesota River have become significantly eutrophied and it is considered one of the most polluted rivers in the United States (Minnesota River Basin Data Center, 2003). The river water quality no longer met expectations for drinking, swimming, industrial and agricultural uses in 2004 (Breetz, et al., 2004).

The Minnesota Pollution Control Agency established a dissolved oxygen target in the Lower Minnesota River in 2004 and has implemented a two-phase approach to remediate the river. Phase I consisted of setting Biological Oxygen Demand (BOD)¹³ discharge limits for wastewater treatment plants in the lower reaches of the river and establishing a 40 per cent BOD reduction goal upstream of Shakopee (Breetz, et al., 2004). Phase II consisted of reducing phosphorus concentrations by 30 to 50 per cent upstream of the Twin Cities (Minneapolis and St. Paul) to achieve the 40 per cent BOD reduction goal (Breetz, et al., 2004). Phosphorus was targeted because it induces algal growth, which increases BOD and lowers dissolved oxygen as it decomposes (Gunderson & Klang, 2004). These goals provided the impetus for establishing a phosphorus discharge permit system to lower phosphorus discharge loads. In addition, large point source emitters have been asked to develop phosphorus management plans to meet a phosphorus concentration of 1 mg/L per year by 2015 or participate in a point-to-point source trading program to reduce their emissions by 35 per cent within five years (Gunderson & Klang, 2004). All point sources were asked to examine the feasibility of reducing their phosphorus emissions by 30 to 50 per cent.

¹³ Biological Oxygen Demand refers to a procedure for measuring water quality where the oxygen consumed by microorganisms to decompose organic matter is measured.

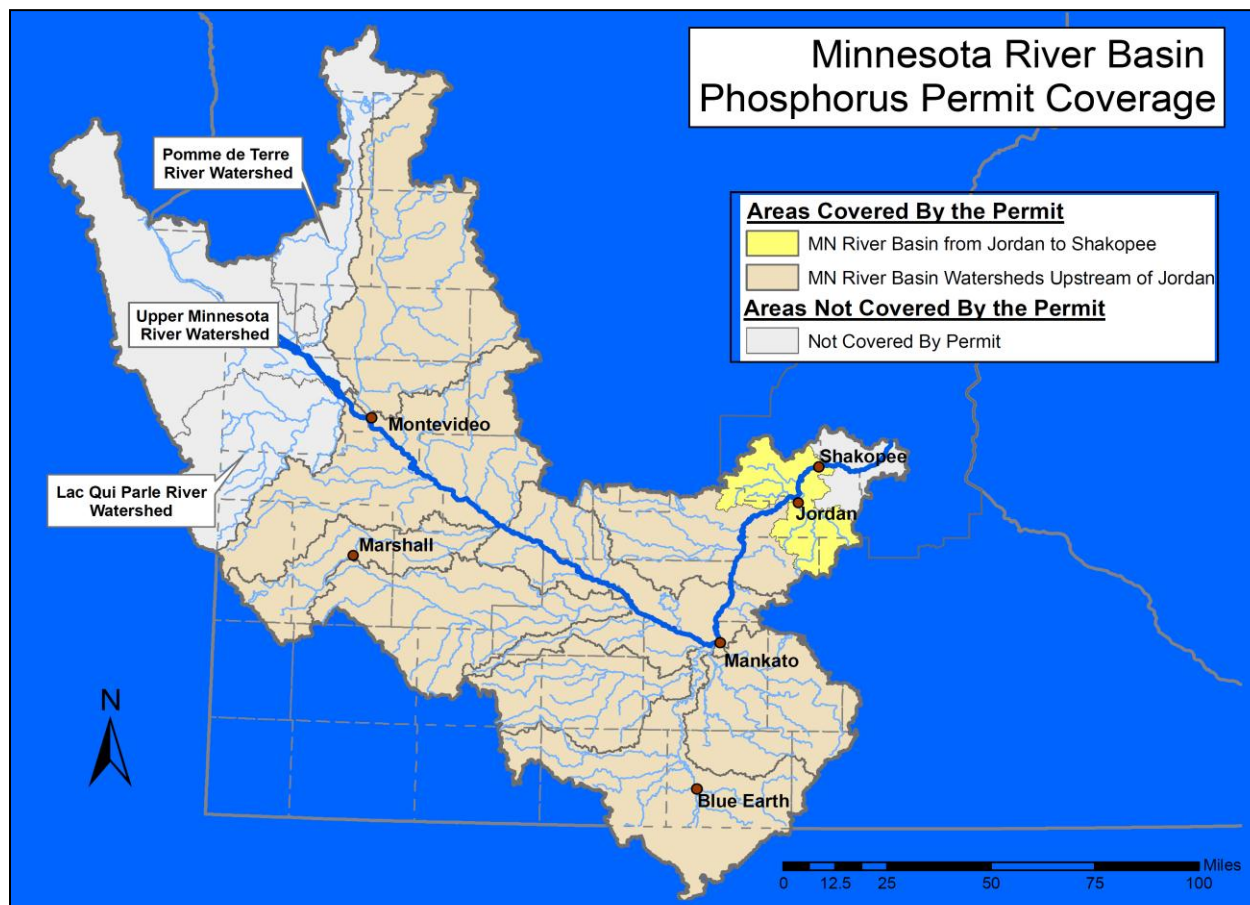

Figure 7: The Minnesota River Basins covers 20 per cent of the State of Minnesota. The Minnesota River basin trading Program has been implemented in the majority of the Basin (Hall, n.d.)

A point-to-point source WQT system was established by the Minnesota Pollution Control Agency in 2005 to provide wastewater treatment plants with the flexibility to upgrade their treatment capacities to meet present and future regulations (Breetz, et al., 2004; Minnesota Pollution Control Agency, 2007b). Trading is bilateral and occurs between wastewater treatment plants that have and do not have the capacity to meet their phosphorus discharge permit allocations. A 1.1:1 trading ratio is implemented for point-to-point source trading. A 45-member advisory committee and the Minnesota River Assessment Project develop strategies to lower phosphorus loads into the water bodies of the basin by assessing land use change impacts and identifying pollution source.

The Rahr Malting Company (RMC) and the Southern Minnesota Beet Sugar Cooperative (SMBSC) established phosphorus offset trading programs with the Minnesota Pollution Control Agency within the Minnesota River Basin. These companies invested in reducing upstream nonpoint phosphorus emissions to offset required expenditures to meet wastewater emission regulations. The

regulatory driver for the emission reduction requirement stems from a Carbonaceous BOD5 TMDL for the Lower Minnesota River.

The RMC established the Minnesota River Corporate Sponsorship Program with a US\$275,000 fund to select nonpoint phosphorus emission mitigation projects. The company achieved its targets by investing in two stream bank stabilization and two floodplain restoration projects (Breetz, et al., 2004). The trades occurred directly between the RMC and local farmers and a trading ratio of 2:1 was used. It is estimated that the RMC paid approximately US\$8.56/lb of phosphorus as opposed to US\$4-18/lb in wastewater treatment capital and operating costs (Breetz, et al., 2004).

The SMBSC established a trade board and a US\$300,000 trust fund to administer its nonpoint source trades. It invested in growing spring cover crops on 36,000 acres of beet fields to offset 5,000 lbs of phosphorus emissions per year. Trades occurred through a clearinghouse between the SMBSC and sugar beet farmers and cattle ranchers in the lower two thirds of the Minnesota River Basin. A trading ratio of 2.6:1 was applied to reflect the offset (1 lb), an environmental improvement (1 lb) and an engineering safety factor (0.6 lb) (Breetz, et al., 2004). The cost of nonpoint source phosphorus offsets was estimated to be US\$18.65/lb of phosphorous, which is excessive when compared to expenditures required to achieve a 1.5 to 1 mg/L phosphorus concentration from a medium wastewater treatment plant. Nevertheless, the SMBSC insists that this is a reasonable price to pay since it is aiming to achieve zero discharge.

Key features...

- *Minnesota River is one of the most eutrophied in the U.S. primarily due to agricultural runoff.*
- *Phosphorus TMDLs provided the impetus to set up water quality trading programs.*
- *A number of water quality trading arrangements co-exist in the basin.*
- *Trading provides point sources in the basin with additional options to meet regulations.*

WQT is being applied in various ways by the Minnesota Pollution Control Agency to remediate the waters of the Minnesota River. In addition to point-to-point source trading, two successful point-to-nonpoint source trading arrangements have been made. Although further refinements may be required these WQT programs have led to some cost-effective phosphorus emission reductions within the basin.

3.3 Tar-Pamlico Nutrient Reduction Trading Program, North Carolina

The Tar-Pamlico River drains a surface area of approximately 11,650 km² into the South Atlantic Gulf (Breetz, et al., 2004). The landscape comprises of approximately 69 per cent forest cover, 2 per cent urban and 29 per cent agricultural lands. Point and nonpoint phosphorus and nitrogen sources have led to the eutrophication of the Pamlico River and Estuary. The Tar-Pamlico was consequently

classified as Nutrient Sensitive Waters in 1989. In response, the Division of Environmental Management initiated the development of a nutrient management strategy that included stricter nutrient discharge limits for point sources. This represented required expenditures of US\$50 million to mitigate point sources even though 80 per cent of the nutrient load originates from nonpoint sources.

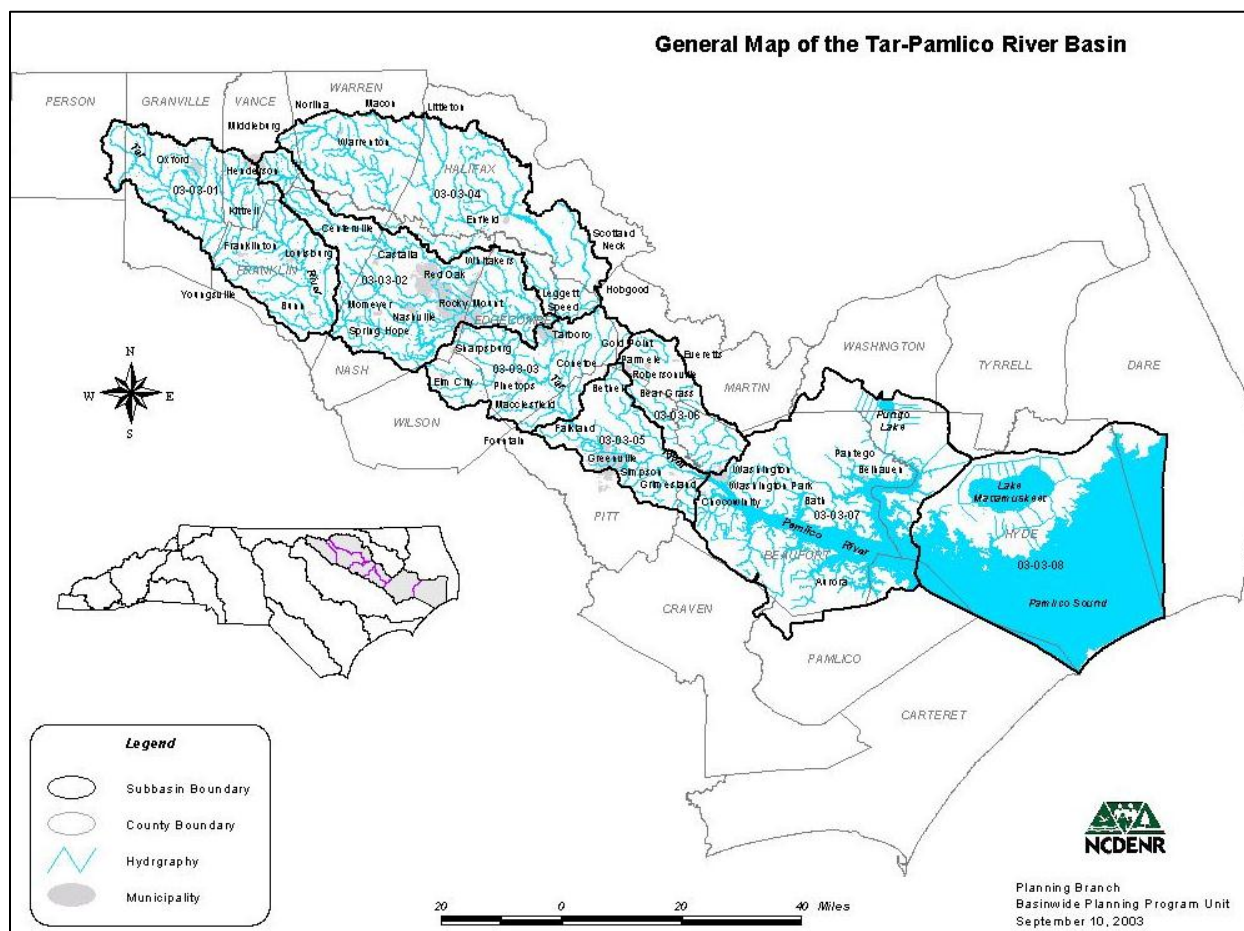

Figure 8: The Tar-Pamlico River Basin and its location within North Carolina (North Carolina Division of Water Quality, 2003)

The Tar-Pamlico Basin Association, representing 94 per cent of the basin's point sources, was formed to develop cost-effective alternatives for addressing point and nonpoint sources with the Environment Defense Fund and the Tar-Pamlico River Foundation (Breetz, et al., 2004). The association shares a common nitrogen and phosphorus cap and members of the association can trade amongst themselves to meet it. If the cap is exceeded, the association must offset its emissions by investing in mitigating nonpoint sources. It does so by paying a fixed price per kilogram of phosphorus to the North Carolina Agricultural Cost-Share Program administered by the Division of

Soil and Water Conservation (DSWC). The funds are then used to pay farmers up to 75 per cent of Best Management Practices (BMP) implementation costs (Breetz, et al., 2004).

Phase I, which lasted from 1990 to 1994, consisted primarily of making improvements to existing point sources and investing in nutrient modelling, demonstration projects and identifying potential trades (BMP implementation projects). Phase II, spanning from 1995 to 2004, focused on lowering nutrient loads from nonpoint sources. However, the association was well below its caps and no trades took place during this time period. Phase III, which will take place from 2005 to 2014, establishes new nutrient caps, offset rates and offset alternative options and resolves temporal issues. Thus far, \$800,000 has been invested in demonstration projects but no point-to-nonpoint trades have taken place within basin (Breetz, et al., 2004).

The Agricultural Cost-Share program acts as a trading clearinghouse between the association and implementers of nonpoint source mitigation projects. The price for a kilogram of phosphorus is fixed based on capital costs, maintenance costs, BMP effectiveness and BMP life expectancy. Effectiveness is estimated based on BMP empirical studies such as conservation tillage, terracing and buffer strips conducted in the Chesapeake Bay. A Nitrogen Loss Evaluation worksheet developed by the North Carolina State University was approved in 2003 and is now used to estimate nitrogen reductions from agricultural BMPs. A trading ratio of 2.1:1 is applied to all point-to-nonpoint trades to account for uncertainties and administrative costs. The state assumes responsibility for monitoring and verifying the implementation of BMPs.

Key features...

- *Despite the lack of trading, the establishment of the water quality trading program has led to notable economic and environment benefits.*
- *The trading programs were rolled out in three distinct time periods.*
- *Trades are administered by the Agricultural Cost Share program.*
- *Credits can be banked, leading to the funding of a number of demonstration projects.*
- *Point sources share a common nutrient cap and excess emissions can be offset by purchasing nonpoint source nutrient credits.*
- *A simplified worksheet approach was adopted to estimate nonpoint source credits.*

Even though Tar-Pamlico Nutrient Trading program has yet to experience its first trade, the development and implementation of the program has led to cost-effective water quality improvements. The nutrient management strategy and nutrient caps have mitigated an estimated 100,000 to 200,000 kg per year of nutrient. The association spent approximately US\$2 million to meet the caps which is well below initial compliance expenditure projections (US\$50 to \$100 million for technological upgrades and US\$11.8 million for agricultural BMP offsets) (Breetz, et al., 2004). The nutrient-trading framework has enabled point sources to be proactive and innovative in their efforts to reduce their phosphorus emissions to meet present and future caps. Despite the economic and environmental successes of the Tar-Pamlico Nutrient Reduction Trading Program,

environmental organizations have criticized it for having high nutrient caps and low reduction goals, which has led to a lack of trading between point and nonpoint sources (Breetz, et al., 2004).

3.4 Chesapeake Bay Watershed Nutrient Trading Program

The Chesapeake Bay is the largest estuary in the United States and its multi-jurisdictional watershed comprises six states (Pennsylvania, Virginia, West Virginia, Maryland, Delaware and New York) and the District of Columbia, covering an area of approximately 166,534 km² (Breetz, et al., 2004). Chesapeake Bay has a long history of suffering from eutrophication due to increased population, agricultural runoff and industrial development. The states that make up the bay have been working cooperatively to improve its water quality since 1983 (Breetz, et al., 2004). WQT is viewed as a potentially innovative way to rapidly and cost effectively lower nutrient loads in the bay.

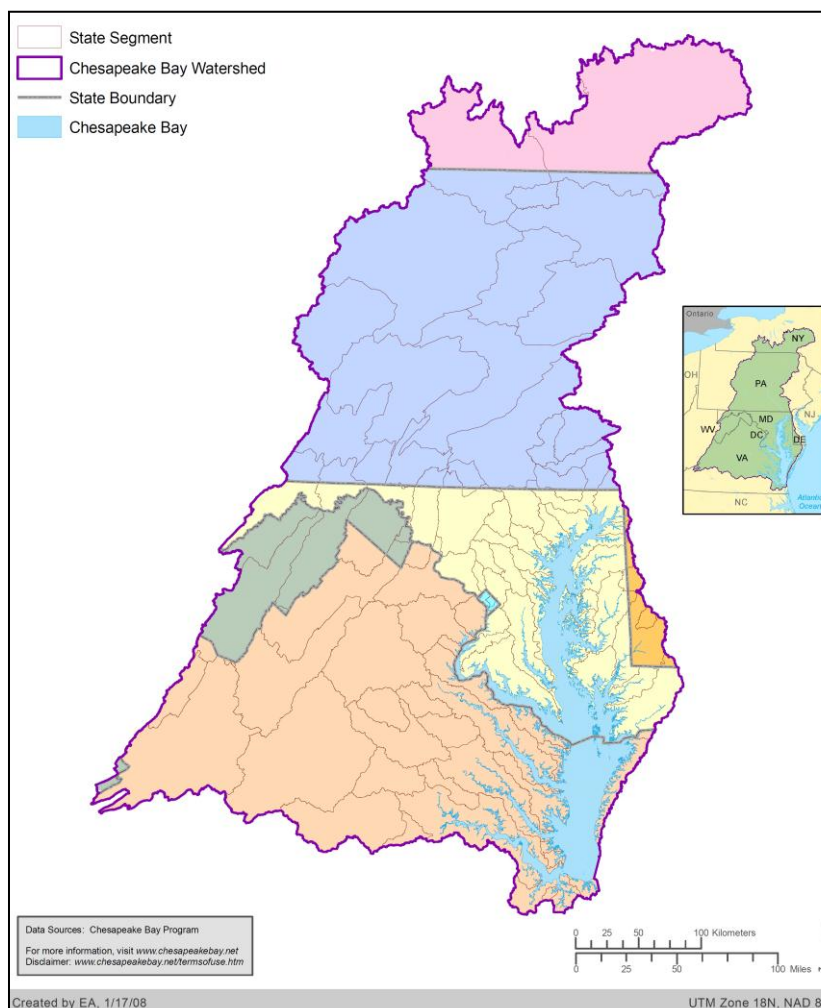

Figure 9: The Chesapeake Bay watershed with sub-watershed and state divisions. (Chesapeake Bay Program, 2008)

The Chesapeake Bay agreement, established in 2000 by the member states, articulates the implementation of a collective phosphorus and nitrogen cap for the bay. Discharge allocations based on the collective cap were determined for each state in 2003. Total maximum daily loads (TMDLs) for the bay and impaired tributaries within its watershed are currently being developed by the U.S. EPA and will be in place by 2010. Nutrient trading guidelines were drafted in 2000 by the Nutrient Trading Negotiation Team and approved in 2001 by all member states. The guidelines advocate for trading aligned with state policies as opposed to trading based on individual contracts to ensure that state water quality improvement efforts are coordinated. They also specify that buyers are responsible for complying with their permits and ensuring that enough credits are supplied. Thus far, interstate trading has not taken place and trading is likely to first occur between publicly owned wastewater treatment plants, industrial point sources, urban runoff, agricultural sources and oyster farms within each state. This implies that a staged WQT approach, starting with intrastate trading to eventually move into interstate trading, is best suited for the Chesapeake Bay context.

The Chesapeake Bay nutrient trading guidelines have provided each member state with a way forward to develop their own nutrient trading frameworks. The States of Pennsylvania and Virginia both developed WQT programs in 2006 (Greenhalgh & Selman, 2008). Although they share similarities, they differ in many respects. The States of Delaware, Maryland and West Virginia are still working on developing state-wide WQT programs.

Pennsylvania established a point-to-nonpoint source trading program to lower nutrient and sediment loads in its water bodies. Credits are bought and sold via a website (<http://pa.nutrientnet.org>), which acts as a clearinghouse. The website was developed by the World Resource Institute and is administered by the Department of Environmental Protection. The prices are influenced by supply and demand and a distinction is made between structural and non-structural BMPs (Borisova, Blunk Saacke, Abdalla & Parker, 2007). Trading ratios account for hydraulic pollution transport processes, potential failure of credit-generating activity and amount of land applied nutrients reaching surface waters (Borisova, et al., 2007). WQT has taken place within Pennsylvania and the state piloted a trading program in the Conestoga River watershed to guide the development of their trading guidelines.

The State of Virginia developed a point-to-point source trading program to lower nutrient loads. Point-to-nonpoint trading is being explored under the Chesapeake Bay program (Breetz, et al., 2004). Trading rules are established by the Virginia Nutrient Credit Exchange Association and a Water Quality Improvement Fund supports wastewater treatment plant upgrades and BMP implementation (Borisova, et al., 2007). No actual water quality trades have taken place within Virginia, but they are expected to take place when the U.S. EPA's TMDLs are enforced or implemented as it will act as a regulatory cap and encourage trading. Trading ratios are determined based on delivery factors.

Key features...

- *The only multi-jurisdictional water quality program in the U.S. with nutrient trading guidelines drafted and approved by the member States.*
- *Each state has developed their own water quality trading programs based on guidelines developed for the watershed.*
- *TMDLs will likely increase water quality trading activities within the watershed.*
- *Pennsylvania uses an online tool to administer trading between point and nonpoint sources.*
- *The World Resource Institute had a catalytic role in conceiving and implementing WQT in the Chesapeake Bay.*

Although very little actual trades have taken place among and within states, progress continues to be made to facilitate future WQT within the Chesapeake Bay watershed. Washington D.C. and the States of Maryland, Virginia and Delaware are working on harmonizing the water quality standards that may facilitate inter- trading. Interstate trading may be triggered by the TMDLs for the bay, which will be established in 2010.

3.5 Murray-Darling Basin Salinity Credit Scheme, Australia

The Murray-Darling River Basin in South Eastern Australia covers 1,061,469 km², which corresponds to approximately 14 per cent of the Australian landmass (Thampapillai, 2006). Spanning five jurisdictions (Queensland, New South Wales, Australian Capital Territory, Victoria and South Australia), it supplies 75 per cent of all domestic, industrial and agricultural water uses and an important portion of Australia's agricultural production (50 per cent in 2001) (Adamson, Mallawaarachchi & Quiggin, 2007; Thampapillai, 2006). The basin has been experiencing rising algal blooms, salinization and water logging due to increasing water consumption, agricultural activity and loss of deep rooted native trees (McNamara, 2007; Thampapillai, 2006).

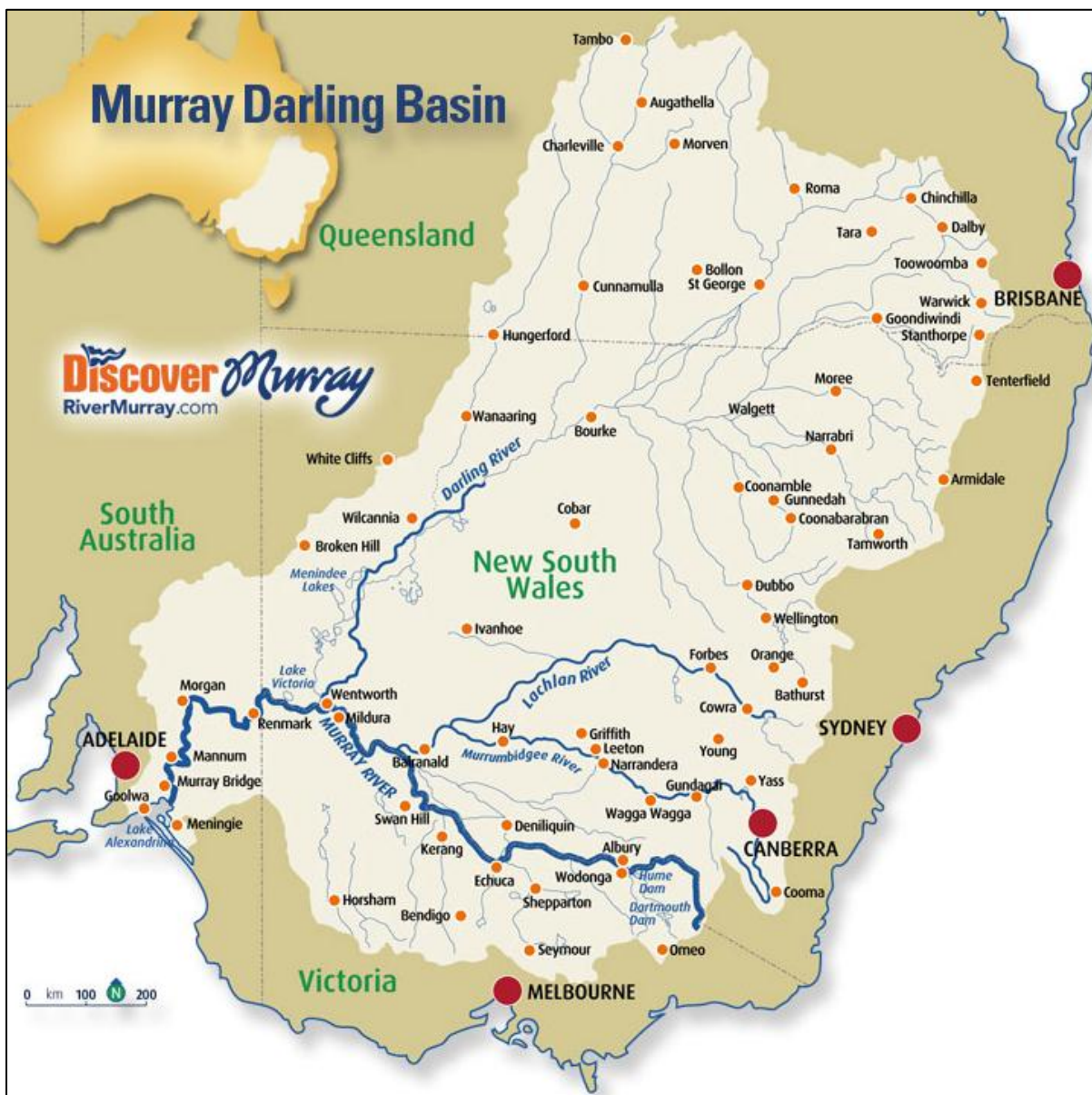

Figure 10: The Murray-Darling Basin showing the location of Morgan where the salinity level for the basin is monitored (Discover Murray, 2008)

As part of the efforts to remediate the water bodies of the Murray-Darling Basin, water trading arrangements were established in 1992 and an interstate water trading system was piloted in 1998. The basin salinity management strategy (BSMS), established by the Murray-Darling Basin Commission (MDBC) in 2001, set river salinity targets for each tributary and the basin system. The BSMS provided guidance on which to build a salinity trading program (Murray-Darling Basin Commission, 2001). Salinity credits are strictly held by participating states as opposed to individual

sources (Greenhalgh & Selman, 2008). The basin salinity credit scheme administered by the MDBIC registers projects and operational policies that increase or decrease salinity. For instance, salt interception projects yield credits while constructing irrigation drains, installing groundwater pumps and flushing wetlands yield debits. The Australian government granted the MDBIC AU\$500 million in 2005-2006 to accelerate the implementation rate of the BSMS and related programs (Murray-Darling Basin Commission, 2007).

Engineering (salt interception schemes) and non-engineering solutions (land and water management plans) are used to lower salinity concentrations. Salt interception projects carried out in Waikerie, Woolpunda and Bookpurnong in South Australia, Mildura-Merbein in Victoria and Mallee Cliffs in New South Wales have reduced salinity concentration in the Murray River by 63.7 EC (Electrical Conductivity) (Murray-Darling Basin Commission, 2006). Highly saline groundwater is diverted from the Murray River into disposal basins. The states that contribute financially to salt mitigation projects are compensated with salinity credits, which are used to carry out drainage and irrigation projects. Changes to land and water management such as irrigation system rehabilitation and improved efficiency can also generate salinity credits. The BSMS stipulates that states cannot approve any developments that could adversely impact salinity concentrations of the Murray River unless salinity credits have been earned by contributing to salinity mitigation projects (Murray-Darling Basin Commission, 2006).

The basin salinity target is measured at Morgan, located at approximately 200 km from the Murray-Darling Basin outflow and is to be maintained below 800 EC 95 per cent of the time. To better understand the salinity impacts of various projects and policies the Salinity and Landuse Simulation Analysis (SALSA) model was developed (Beare, Heaney & Mues, 2001). The model provides a means by which relationships among land use, vegetation cover, surface and groundwater hydrology and agricultural returns can be explored. The BSMS has been successful in reducing the average and peak salinity concentrations of the Murray-Darling River Basin. The MDBIC reported that salt interception projects mitigated approximately half a million tonnes of salt from the river system in 2007-08 (Murray-Darling Basin Commission, 2008). **Figure 11** shows the overall reduction in salinity concentration with and without the salinity mitigation efforts.

The Independent Audit Group for Salinity reported in 2007 that: the offset target of 61 EC at Morgan will be reached by 2010-2011; significant progress has been made to improve farming water use efficiency; all jurisdictions have produced timely and high quality reports (Murray-Darling Basin Commission, 2008). The report also pointed out that a better understanding was required in the following areas: salinity risks from activities near rivers, floodplains and drylands; salt movements from floodplains during flooding events; potential salinity impacts from industrial developments such as coal steam gas extraction and intensive livestock operations (Murray-Darling Basin Commission, 2008).

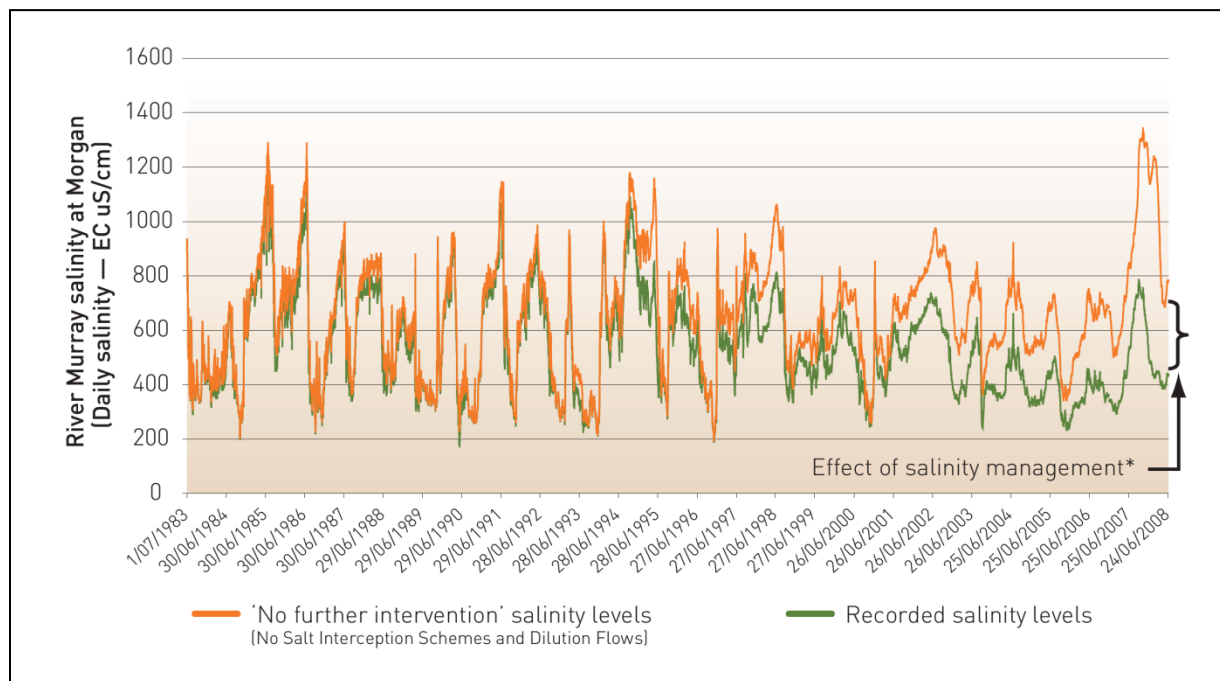

Figure 11: Estimated salinity levels without intervention and actual levels measured at Morgan located at approximately 200 km of the basin outflow (Murray-Darling Basin Commission, 2008, p. 47)

It must be noted that the National Water Initiative, developed in 2004, is expected to influence and ultimately supersede all state and territorial water management arrangements by 2014. A roadmap towards the implementation of the National Water Initiative and national water trading regime have been drafted (Thampapillai, 2006). Despite a prolonged drought, progress has still been achieved through the Murray-Darling Basin salinity credit system to lower salinity concentrations within the basin. The National Water Initiative will likely strengthen current water management initiatives and provide a foundation for future national water quality and quantity trading systems.

Key features...

- *The Murray-Darling Basin is comparable in size to the Lake Winnipeg Basin.*
- *Trades strictly occur between states within the basin.*
- *The Basin Salinity Management Strategy has been successful in lowering salinity levels despite drought conditions.*
- *National Water Initiative provides a foundation to develop a national water quality program.*

3.6 Insights for the Lake Winnipeg Basin, Canada

A number of lessons learned can be gleaned from the WQT case studies presented. The implementation of WQT programs can be nested and occur within large multi-jurisdictional basins.

A shared and common vision is required for the water quality of the Lake Winnipeg Basin. The process of setting up WQT trading can lead to water quality improvements. A number of WQT trading schemes can coexist in the same watershed. Incorporating nonpoint sources trading within a WQT program needs to be approached strategically to ensure that their inclusion leads to real water quality improvements. The right mix of penalties and incentives are required to encourage trading partners to follow the trading rules and reduce emissions through trading activities.

Table 4: Water Quality Trading Systems Examined

Water Quality Trading System	Total Area	General Description	Key Features	Benefits
Grassland Area Farmers Tradable Loads Program	1500 km ² of tilled agricultural land in the San Joaquin watershed	Implemented in 1998 to lower selenium concentrations from nonpoint agricultural sources	Selenium concentrations are measured at 62 drainage pump locations. Fines are applied if aggregate cap is exceeded but impositions waived due to natural circumstances.	39 trades valued at \$14,320 have led to a 61 per cent decrease in selenium emissions (from 9,600 to 3,700 lbs).
Minnesota River Basin Trading Program	The Minnesota River Basin covers 43,434 km ² . Agriculture accounts for 92 per cent of land use in the basin.	The lower reaches of the Minnesota River is the most polluted river in the United States due to eutrophication. Point-to-point source trading initiated to achieve BOD targets established in the basin. The Rahr Malting Company and the Southern Minnesota Beet Company invested in upstream nonpoint nutrient reductions to meet their targets.	Phosphorus TMDLs was the driver for establishing WQT programs. Large point emitters must reduce their P emissions to 1 mg/L or reduce emission by 35% by participating in a WQT program. A number of WQT arrangements co-exist in the basin (both point to point and point to nonpoint nutrient trading).	The Rahr Malting Company paid \$8.56/lb of P through WQT as opposed to \$4-18/lb though wastewater treatment capital and operating costs. The Sugar Beet Cooperative paid \$18.65/lb of P.
Tar-Pamlico Nutrient Reduction Trading Program	The Tar-Pamlico river drains a surface area of 11,650 km ² into the South Atlantic Gulf.	The Tar-Pamlico River was classified as a nutrient sensitive in 1989 due to eutrophication being experienced in the Pamlico River and the	Trades are administered by the Agricultural Cost Share Program. Credits can be banked and can fund demonstration	The nutrient management strategy is mitigating 100 to 200 kg of nutrients per year. \$2 million has been spent thus far, which is below initial

	Approximately one third of the watershed is used for agriculture	Estuary. A nutrient reduction strategy is being implemented in three phases which includes provisions for point-to-nonpoint source trading.	projects (\$800 thousand has been spent thus far). Point sources share a nutrient cap and excesses can be offset via nonpoint source nutrient credits. Uses a simplified worksheet to estimate nonpoint source credits.	compliance expenditure projections (\$50 to \$100 million for technological upgrades and \$11.8 million for agricultural BMP offsets).
Chesapeake Bay Watershed Nutrient Trading Program	The Chesapeake Bay is the largest estuary in the United States and it receives water from an area covering 166,534km ² .	The bay has a long history of suffering from eutrophication due to development. The states (plus D.C.) that make up the bay have been working cooperatively since 1983. WQT is viewed as a potential way to reduce nutrients rapidly and cost effectively.	The only multi-jurisdictional WQT program in the United States. Each state has or is developing their own WQT guidelines for their watersheds. The World Resources Institute had a catalytic role in implementing WQT for Chesapeake Bay. Nutrient Net is an online tool used to administer point-to-nonpoint source trades in Pennsylvania.	WQT has taken place in Pennsylvania. Water quality standards are being harmonized among the other states, which may facilitate interstate trading in the future.
Murray-Darling Salinity Credit Scheme	Located in South-Eastern Australia, this basin covers 1,061,469 km ² corresponding to approximately 14per cent of the Australian landmass and covering five jurisdictions.	The basin, which supplies 75 per cent of all domestic, industrial and agricultural water uses, has been experiencing algal blooms, salinization and water logging due to water consumption, agricultural activity and loss of native tress. Water trading arrangements were established in 1992 to address the situation.	Trades occur strictly among the states that make up the basin. Salinity targets have been set for each tributary. Salt interception projects yield credits while salt generation projects yield debits. Developments cannot impact salinity concentrations unless salinity offset credits have been purchased.	Salt interception projects mitigated half a million tonnes of salt from the river system in 2007-08. The offset target will be reached by 2010-2011 Despite a prolonged drought, the Murray-Darling Basin salinity credit system has been successful in lowering salinity concentrations within the basin.

The implementation of WQT programs within large multi-jurisdictional watersheds like the Chesapeake Bay and the Murray-Darling Basin demonstrates that WQT can be beneficial at a number of spatial scales. WQT programs can be nested. Interstate and intrastate trading is possible and can be phased in over time to suit particular regulatory and institutional contexts. An interstate WQT program is currently operating within the Murray-Darling Basin, while an intrastate WQT program that could eventually include interstate trading is currently underway in the Chesapeake Bay.

The WQT programs established for the Chesapeake Bay and the Murray-Darling Basin highlight the need for establishing a collective vision and an overarching entity, one that spans across jurisdictions, whose sole purpose is to improve water quality within the watershed. The Chesapeake Bay Agreement is a seminal document that professes the intention of all member states to lower their nutrient loads on the bay. A similar document may be required for the provinces and states that make up the multi-jurisdictional Lake Winnipeg Basin. The Murray-Darling Basin Commissions, armed with the Basin Salinity Management Strategy, works across jurisdictions and has been successful in lowering the salinity concentrations within the basin despite increased drought conditions.

The process of establishing a WQT system can lead to significant water quality improvements before trading activities are initiated. As demonstrated in the Tar-Pamlico Nutrient Trading Program, the development of a WQT program is usually accompanied by imminent water quality targets that motivate trading partners to lower emissions internally before engaging in trading activities. The very process of implementing a WQT system in the Lake Winnipeg Basin could lead to significant improvements in the lake's water quality.

As demonstrated in the Minnesota River Basin and the Chesapeake Bay watershed, a number of WQT programs can coexist in the same watershed. This may be a necessity in the formative stages of setting up a WQT program in the Lake Winnipeg Basin. In addition, nonpoint-to-nonpoint source trading may be possible provided that a suitable monitoring system is in place. Although a common vision will be required to develop a coherent WQT program for the Lake Winnipeg Basin, flexibility in its application may be required in its initial implementation.

Point-to-nonpoint source trading is possible and must be adequately designed to ensure the successful implementation of a WQT program. The use of pilots can be effective in designing an adequate point-to-nonpoint source trading system. As demonstrated in the Tar-Pamlico watershed, a phased approach was adopted that included financial support for pilot projects to test the generation of credits via nonpoint nutrient sources mitigation efforts. A phased approach to implementing a WQT program seems to be effective in ensuring that nonpoint sources can be incorporated successfully. In the case of the Tar-Pamlico Nutrient Trading Program, a group discharge limit or

cap was established for all point sources with mechanisms to access offset credits from nonpoint sources to be phased in over time. Another way to handle nonpoint sources is to monitor them at their point of convergence so they can be treated as a combined point source. This approach was demonstrated by the Grassland Area Farmers Tradable Loads Program, which treated drainage districts as point sources by monitoring their outflows.

The right mix of penalties and incentives are required to ensure that trading partners will comply with trading rules and protocols. In the case of the Grassland Area Farmers Tradable Loads Program, the use of the drain is cut if the target is exceeded by 20 per cent, fine impositions are waived due to natural circumstances and fines are redistributed as rebates to compliant trading partners. The vastness and multi-jurisdictional nature of the Lake Winnipeg Basin implies that a range of creative penalties and incentives may be required to encourage appropriate trading scales and processes.

4.0 Implementing Water Quality Trading in the Canadian Prairies

Designing and implementing a WQT system to mitigate the nutrient loads impacting the water bodies of the prairie landscape requires a number of important considerations. A regulatory basis is required to limit the nutrient loads that can be discharged within prairie watersheds. This will motivate dischargers to either buy or generate and sell offset nutrient emission credits. Due to the large contribution of nonpoint sources to the overall nutrient load flowing into the water bodies of the Canadian Prairies, adequate methods and tools are required to estimate potential mitigation benefits. An adequate monitoring framework is required to track trading compliance, the state of water quality and overall outcomes associated with a WQT system at the watershed scale.

4.1 The regulatory basis

The process of designing and introducing a tradable permit system requires regulatory and institutional reform of an existing water pollution control system (Organization for Economic Cooperation and Development, 2001). Key elements in regulatory and institutional reforms recommended by the OECD (2001) include:

- A shift from regulations focused on technology choice to the formulation of physical constraints, such as ambient water quality standards that are more in line with environmental objectives and offer greater flexibility in the choice of means to achieve compliance.
- A shift from environmental standards expressed in terms of unit and concentration value to those expressed as absolute/mass values (a given load per time period).
- Assignment of responsibility for verifying policy implementation to independent administrative authorities whose long-term mission is to ensure compliance with regulations and to develop transfer activity and fair transactions.

4.1.1 The Canadian context

An analysis of the Canadian federal and provincial legislation and regulations indicated that the requisite regulatory cap or any facsimile thereof necessary for a WQT framework does not exist. Nevertheless, there are no significant legislative barriers to overcome for the development of a WQT framework. An overview of federal and provincial acts relevant to this research with their primary focus and sections most relevant to a WQT framework are tabulated below. This analysis builds on a similar analysis of legislation conducted by Tri-Star Environmental Consulting (2006).

Table 5: Canadian legislation for the establishment of a WQT system

Canadian Federal Legislation
<p>Canadian Environmental Protection Act controls substances harmful to the environment and provides a way for Canada and the provinces to jointly coordinate the development of environmental quality objectives, guidelines and codes of practice. Indirectly, the Act will affect water users through the control of nutrients, the application of various provisions related to toxic substances and the use of the <i>Canadian Water Quality Guidelines</i>. Section 327 of the Act gives “the Minister (of Environment) the authority to establish guidelines, programs and other measures for the development and use of economic instruments and market-based approaches to further the purposes of this Act, respecting systems relating to (a) deposits and refunds; and (b) tradable units.” Further along in section 330, the Minister is given the authority for general regulations that prescribe the (a) minimum, average or maximum quantity or concentration of the substance, and the method of determining such a quantity or concentration.</p>
<p>Canada Water Act regulates discharge of waste into “prescribed water quality management areas,” and establishes federal water quality management programs for inter-jurisdictional waters. If required, water quality management areas can be established to provide additional power to regulate pollution. In section 13 of the Act, title federal programs respecting inter-jurisdictional waters, the Act states that where the water quality management of any inter-jurisdictional water has become a matter of urgent national concern, the Governor in Council, subject to subsection (2), may, on the recommendation of the Minister, “designate those waters as a water quality management area and authorize the Minister to name an existing corporation that is an agent of Her Majesty in right of Canada, or that performs any function or duty on behalf of the Government of Canada, as a water quality management agency to plan, initiate and carry out programs” described in section 15 in respect of those waters.</p>
<p>Canadian Environmental Assessment Act establishes a framework for evaluating the environmental effects of proposed development. The Act can have an effect on water users who want to participate in or who would be affected by projects with federal involvement. It has minimal relevance to WQT of pollution credits.</p>
<p>Fisheries Act provides protection of fish, fisheries and fish habitat from pollution, prohibiting the deposition of harmful substances into fish-bearing waters or watercourses that may eventually enter fish-bearing water. Harmful substances include suspended solids, fertilizer, manure, fuel and pesticides. The Act also prohibits “harmful alteration, disruption or destruction” of fish habitat. Municipalities could be in violation of the Act if their effluent is harmful to fish.</p>
Alberta
<p>Environmental Protection and Enhancement Act, under the Minister of Environment, provides an extensive framework for evaluating the impacts of a proposed development on water quality, protecting both surface and ground water, regulating deposition of harmful substances into water bodies, and managing land and water based activities that can have a significant impact on the quality of water supplies. Section 13 gives the Minister (of provincial environment) the power to establish programs and other measures for the use of economic and financial instruments and market-based approaches, including, without limitation, emission trading, incentives, subsidies, emission, effluent and waste disposal fees, and differential levies.</p>
<p>Water Act contains broad powers to prevent impacts on water and water management. It stipulates that, unless authorized under the Act, no one can carry out an activity that affects or could affect the flow, level or location of water or its direction, or that causes or could cause siltation or erosion or an effect on the aquatic environment. Activities requiring approval are generally those carried out in the river, on its banks, or in the</p>

floodplain of a river.
Agricultural Operations Practices Act (AOPA) identifies nitrogen as the limiting nutrient in the soil profile. The application of manure to meet the nitrogen requirements of typical crops grown in Alberta can result in significantly more phosphorous than is required to grow a crop. The AOPA sets out manure management standards for all agricultural operations in Alberta to support the growth of the livestock industry and, at the same time, help reduce the risks to the environment. The Standards and Administration Regulation of AOPA establishes standards for storage facility design, application limits, application setback distances from water bodies and record keeping and soil testing.
Saskatchewan
Environmental Management and Protection Act (EMPA) deals with point source discharges. Activities covered in the Agricultural Operations Act (AOA) are exempt.
Agricultural Operations Act (1995) outlines nutrient management plans that give producers 10 years to adopt the regulations, which include applications of manure nutrients at agronomic rates to better match nutrients to specific crop needs. It also encourages both manure nutrient testing and soil testing.
Pest Control Products Act addresses using and storing only licensed pest control products in an appropriate manner. It also prohibits the application of a pesticide to an open body of water or its banks without a permit under the EMPA. No permit is required if the water into which the discharge is made does not normally flow off the owner's land.
Manitoba
Water Protection Act provides for the protection and stewardship of Manitoba's water resources and aquatic ecosystems. The Act provides for the establishment of regulations incorporating water quality standards, objectives and guidelines, designating areas of land as water quality management zones and prescribing activities that are prohibited in those zones and controlling the import and intentional movement and transfer of invasive exotic species into the province. The Act also provides for watershed planning, including the development of watershed management plans and designating watershed planning authorities. <i>The ability under the act to establish water quality management zones or water management plans provides an important means of implementing a WQT of pollution credits.</i>
Nutrient Management Regulations , under the Water Protection Act , includes demarcation of water quality management zones, nutrient application restrictions, nutrient buffer zones and winter application restrictions. The nutrient management regulations currently demarcate six water quality management zones based on soil types and set out restrictions on the soil nitrate-nitrogen limits and phosphorous thresholds. <i>This potentially provides the basis for establishing nutrient credit zones for watershed-based nutrient credit trading.</i>
Environment Act provides the authority to issue permits for pollutant discharges. The Environment Act provides the flexibility to be able to vary flows and concentrations in the permits; thereby allowing the trading of pollution credits within watersheds. Specifically, Section 45 of the <i>Environment Act</i> stipulates under the “sale of marketable emission rights” that, “the Lieutenant Governor in Council may, where it is consistent with established environmental quality objectives, market units of allowable emission of specific pollutants, in accordance with the regulations, and the revenue so generated may be held in trust by the Minister of Finance as an environmental Contingency fund, to be used at the request of the minister in the event of an environmental emergency.” <i>This might be the most direct basis in existing provincial legislation for the establishment of an emissions-based market.</i>
Livestock Manure and Mortalities Management Regulation , under the Environment Act , prescribes requirements for the use, management and storage of livestock manure and mortalities in agricultural

operations so that livestock manure and mortalities are handled in an environmentally sound manner. This regulation deals with manure storage facilities and manure handling, including: size, location and operation of storage facilities; permits; decommissioning of storage sites; monitoring; and application.

Ontario

Environmental Protection Act prohibits the discharge of any contaminant into the environment in amounts exceeding limits prescribed by the regulations or the discharge of contaminants into the environment that cause or are likely to cause adverse effects.

Ontario Water Resources Act is meant to protect the quality and quantity of Ontario's surface and groundwater resources. It governs approvals for discharges to water and sewage works. It is administered by the Ministry of the Environment.

Nutrient Management Act provides a framework for setting standards for nutrient management on farms. It includes setbacks from surface water, high trajectory irrigation guns, winter application, snow and frozen soil, approval process, nutrient management plans and sound agronomic principles and practices. It includes specifications for manure handling and storage. The *General Regulations* under this act set out specific details of the legal requirements for the handling and storage of nutrients.

There are elements at both the federal and provincial levels that allow for the development of emissions/pollutant trading or markets. Specifically, the Canadian Environmental Protection Act (CEPA) has a provision for the federal Minister of Environment to establish guidelines, programs and other measures for the development and use of economic instruments and market-based approaches to further the purposes of the act. The Minister has authority to develop regulatory limits and specification for the system. In addition, the Canada Water Act authorizes the Governor in Council, on the advice of the Minister, to identify "prescribed water quality management areas" for inter-jurisdictional water that is impaired and is of urgent national concern. The Minister can then appoint an existing government agency to initiate and carry out water quality management plans to remediate the water body.

Sauve, et al. conducted a review of existing Canadian policy that could support the establishment of a WQT in 2006. Their study of the Canadian provinces revealed that their legislative frameworks offer the basic features of, and the flexibility for, the implementation of WQT to address water pollution from agricultural activities. They further clarified that at least four of the provinces (Alberta, Ontario, Quebec and Nova Scotia) clearly possessed the relevant power to introduce a tradable permit system within their jurisdictions and that all the provinces had the necessary power to establish and impose water quality criteria/objectives. A necessary flexibility to allow offset systems to meet regulatory requirements is demonstrated in the South Nation River Watershed example, where permit holders are allowed to consider a reduction outside their facilities with a higher level of emission reduction (such as the 4:1 ratio adopted by South Nation).

Agri-environmental policies and legislation in the Prairie provinces, including nutrient management planning, also form a basis for the development of a nutrient trading system. Once these policies are

fully developed, Sauve, et al. (2006) suggest that a trading system based on the soil's assimilative capacity of certain types of pollutants can be implemented. The Manitoba example of a prescribed limit for phosphorous on land application of manure under the Nutrient Management Regulation is a clear indication of the practical possibilities for implementing a cap.

A basis for the establishment of the WQT in the U.S. has been the enactment of the Clean Water Act (CWA) in 1972, which aimed to restore and maintain the “chemical, physical and biological integrity of the nation’s water.” The goal is to eliminate the discharge of pollutants into navigable waters. Under the CWA, states need to identify and submit a list of impaired surface waters that do not meet applicable water quality standards after implementation of technology-based effluent limitations or other pollution control programs. Total maximum daily loads (TMDLs) are to be set for these water bodies to establish the maximum amount of a pollutant or pollutants that a water body can assimilate without exceeding existing standards.

4.1.2 The American context

The U.S. Clean Water Act provides the basis for WQT in the United States. The evolution of the regulatory framework for WQT in the U.S. is presented in **Figure 12**.

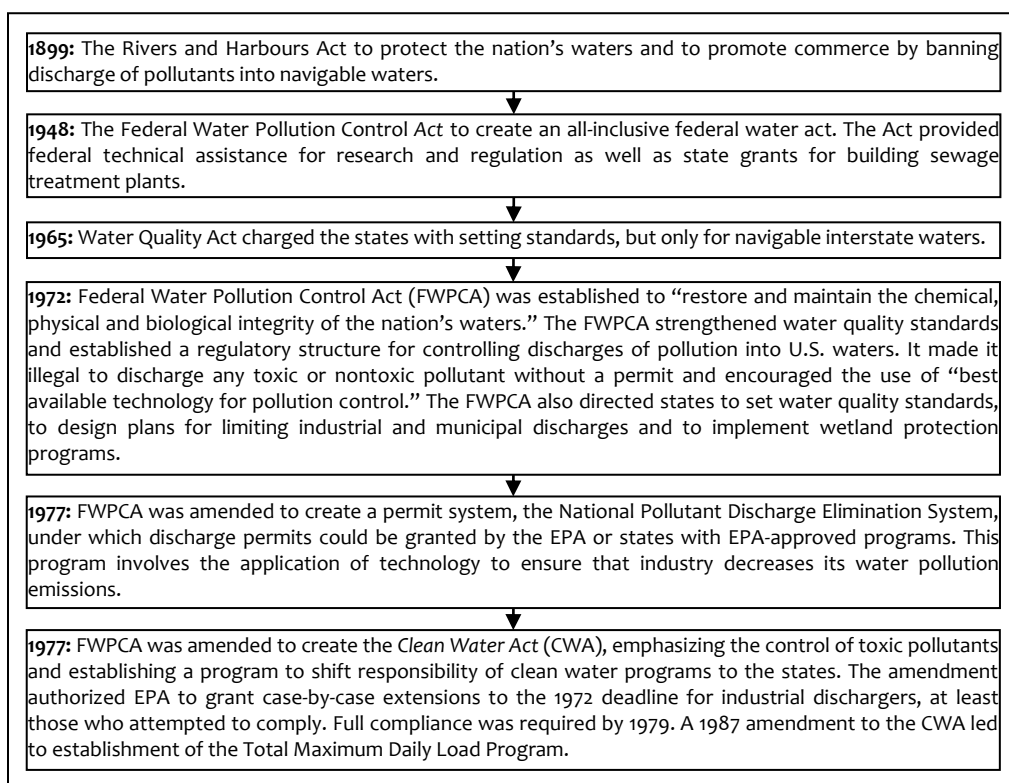

Figure 12: The evolution of water quality legislation in the United States based on Feldman (2007)

Historically, U.S. water law had been fragmented, with authority divided between the state and federal levels and quality and quantity concerns embraced in different sets of regulations. Most policies have been non-statutory and based on precedent, tradition and custom - occasionally amended by specific legislation. Major changes in water quality laws began in the 1960s after a series of prominent and publicly criticized environmental disasters, including a fire on the Cuyahoga River that destroyed several bridges due to high concentrations of chemicals and industrial wastes, 26 million fish kills in Florida's Lake Thonotosassa and an oil spill off scenic Santa Barbara, California. The changes in water policy affected regulations requiring permits and employing command and control techniques to achieve specific quantitative objectives.

The Clean Water Act (CWA) emerged from predecessors including the Federal Water Pollution Control Act (FWPCA) in 1977, and emphasized control of toxic pollutants and established a program to shift responsibility of clean water to the states. Under the CWA, pollutants include dredged materials, solid waste, incinerator residue, sewage and sewage sludge, garbage, munitions, chemical wastes, biological materials, radioactive materials, heat, wrecked or discarded equipment, rock, sand, cellar dirt, and industrial, municipal and agricultural waste discharged to water.

The regulatory basis for the future development of WQT was provided by a stipulation under the CWA called the total maximum daily load (TMDL). Section 303(d) of the U.S. federal Clean Water Act requires states to establish, for any lake, river, stream or other water body that fails to meet federal water quality standards, a TMDL for those pollutants responsible for failure to meet these standards. The value at which TMDLs are set theoretically ensures that water quality standards can be maintained. For this goal, every TMDL contains several parts including a margin of safety. If a state fails to develop adequate TMDLs, the EPA is required to make its own and set priorities for meeting them (Copeland, 2001). While TMDLs largely form the basis for watershed-based nutrient trading in the U.S., the process of developing and instituting TMDLs has been slow and contentious. The main challenges in effectively developing and implementing TMDLs, according to Feldman (2007), are the following:

1. Ensuring that adequate data exists for assessing water quality and developing standards, or if it does not, that it is being collected.
2. Setting appropriate criteria for potential pollutants and establishing milestones for ensuring compliance with the limits imposed by these criteria.
3. Involving stakeholders in TMDL decision-making has been difficult.
4. Avoiding lawsuits by effluent dischargers and environmentalists has been a continuing issue in the implementation of programs to reduce discharges and to establish TMDL limits.
5. Finally, encompassing unique hydrological challenges, such as seasonally variable precipitation and terrain, has been difficult, exemplifying the challenge in encompassing

factors in water quality management that may constantly change, such as the amount of rain that falls or changes in land use.

The issue of TMDL has also been contentious. Not everyone views it as an appropriate solution to the problem. There are three main criticisms of TMDLs: the lack of state authority for nonpoint sources such as logging, mining and agriculture; court challenges to state timetables for developing TMDLs; and the difficulty of developing sound stakeholder representation processes. In addition, the lack of resources dedicated to developing TMDLs, as well as the rigour employed in developing TMDLs, has been questioned repeatedly (Feldman, 2007).

The EPA oversees state water quality protection programs, including trading, through the authority of the CWA. In 2003, the EPA issued a final WQT policy to provide guidance to states and tribes on how trading can occur under the CWA and its implementing regulations (United States Environmental Protection Agency, 2003). The policy requires state trading programs to include timely public access to trade information and public participation in program development and implementation; mechanisms to monitor and evaluate program progress and effectiveness, quantify credits, address uncertainty, and revise the program if necessary; legal mechanisms to facilitate trading; clearly defined trading units and trading accountability; and assurance that National Pollutant Discharge Elimination System permit holders meet their permit limits (Martin, 2007a). A key lesson of this process is the evolution of regulatory components to accommodate trading caps and allow the flexibility to trade these allowances.

4.2 Nutrient offset trading

Nutrient trading within the Canadian Prairies could potentially improve the water quality of the Lake Winnipeg Basin as phosphorus and nitrogen are the main pollutants impacting its water bodies. The majority of the nutrient loads originate from nonpoint sources, which can be addressed by implementing BMPs. This adds a level of complexity to nutrient trading, as measuring water quality improvements associated with BMPs - and by extension their nutrient credit or offset values - can be challenging. Approaches used to estimate the value of BMP offsets are presented in the following paragraphs.

In a WQT system, offsets are purchased by regulated entities and supplied by both regulated entities (point source) with unused compliance credits, and by unregulated entities (nonpoint source). Credits for regulated entities would be produced when a regulated entity emits below its allowed level and sells that excess emission capacity. Credits from non-regulated entities are produced when a change in practice produces an improvement in water quality.¹⁴ For offsets to have a genuine impact on the environment, they must be real, additional, verifiable, permanent and enforceable.

¹⁴ An example would be a farmer increasing a riparian buffer zone to filter out more nutrients from agricultural runoff.

- **Real:** The practice must represent actual loading reductions, and not result from inaccurate science or incomplete accounting.
- **Additional:** The loading reductions from offset projects must be shown to be additional reductions that would not have occurred without the incentive provided by trading revenue.
- **Verifiable:** The practice must result from projects whose performance can be verified.
- **Permanent:** Loading reductions must be everlasting and stipulations must be established to take into account situations where loading reductions become reversed.
- **Enforceable:** Offsets must be consistent with regulations and rules that define their creation, provide for transparency and meet defined standards of ownership.

Offset credits from point source emissions generated by adopting new practices or technological upgrades will likely have a positive impact on the environment that can accurately be measured, as point sources emit directly into water bodies. For nonpoint sources, a tonne of phosphorus emitted on the landscape will not have the same impact as a tonne emitted at another location. Thus, there is a challenge in proving that a reduction is real and verifiable. This requires a profound understanding of watershed functioning, since the benefits produced from improvements in runoff quality will vary depending on the exact location in the watershed the reductions take place. This level of understanding is required for each individual offset project.

4.3 Water quality predictions

While monitoring the Lake Winnipeg Basin is important for gauging progress, predicting the quality of water in the Lake Winnipeg Basin as a result of land use changes is also important. To understand how changing the landscape can lead to water quality improvements, cause effect modelling that captures geospatial variances is required. In a WQT program, this modelling can establish methods or protocols for estimating water quality benefits from offsets. Modelling can also guide the development of a WQT platform by estimating the potential supply of offset credits.

Various levels of modelling are used in WQT. Loading ratios can be used to derive estimates of water quality improvements, as was done in the South Nation WQT program. Decision-making tools can be developed to guide protocol development and trades, as was done with the EcoTender pilot in Australia. For increased accuracy, full dynamic watershed simulation models can be developed or used, such as the Catchment Analysis Tool developed in Australia. When coupled with a comprehensive monitoring program, water quality modelling can be constantly updated and calibrated with new information to increase accuracy (see **Appendix B** for detailed information on water quality prediction approaches).

4.4 Monitoring framework

Monitoring the condition of the large Lake Winnipeg Basin is a complex endeavour. The basin area is diverse, comprises many landscapes and land uses, and hosts a wide variety of stakeholders. Many water quality aspects are presently being monitored by various agencies, including Manitoba Conservation, Manitoba Water Stewardship, Environment Canada and the Department of Fisheries and Oceans. Nevertheless, the Lake Winnipeg Stewardship Board (2006) identifies several areas of concern, such as wastewater treatment, phosphorous loading and shoreline erosion, that require more monitoring.

The U.S. EPA distinguishes between water quality monitoring and watershed monitoring (United States Environmental Protection Agency, 2008). Water quality monitoring focuses on the physical, chemical and biological characteristics of water bodies. Watershed monitoring involves gathering data from water bodies and the landscape to better understand the cause and effect relationships between them and the integrated system.

Whether the intent is to design a program to monitor a watershed or to collect scientific information, a clear objective of what the monitoring must achieve is important. Common objectives for water quality monitoring programs include characterizing conditions and trends, protecting human health, targeting potential water quality programs, designing pollution control programs, assessing program goals and responding to emergencies (United States Environmental Protection Agency, 2008).

The purpose of the WQT programs is to address water quality issues that can impact the well-being of human and environmental systems (M. O. Ribaud & Nickerson, 2009). For this reason, a basin-wide monitoring program associated with a WQT platform should move beyond simply measuring water quality parameters and examine cause-and-effect relationships in an integrated fashion. For example, the relationships between land use change and water quality, or between water quality and recreational enjoyment should be clearly understood. Hence monitoring should take place on three levels: compliance monitoring, water quality monitoring and outcome monitoring.

In many cases, data is already being collected and monitored by various agencies. The challenge for setting up a basin-scale monitoring framework would be to compile and process the data already being assembled, to extract the relevant information for managing water quality in the Lake Winnipeg Basin. The data will come from a variety of sources and will require some processing to extract the required information. These efforts will be best placed within a cross-cutting agency that functions at the basin level that works closely with watershed agencies at the sub-basin level such as the Lake Winnipeg Stewardship Board.

4.4.1 Compliance monitoring

Compliance monitoring is carried out to verify that trading participants are in compliance with their regulatory and contractual obligations. Effluent point sources are typically bound by licence requirements that allow them to discharge effluent or contaminants to receiving waters under certain conditions. These conditions may include specified discharge volumes, discharge temperatures and environmental conditions. Environmental licences may also include a requirement for water quality sampling of the effluent and the receiving waters, both upstream and downstream of the discharge.

Discharges from nonpoint sources, such as farmlands and natural areas, are not regulated by the same legislation as point sources. The need for land use monitoring becomes necessary when landowners enter contracts to sell offsets by carrying out BMPs. Contracts for BMPs will specify that a certain practice be carried out for a specified period of time and a fixed price. Since the contract is based on the implementation of a BMP and not on actual reductions, compliance monitoring should ensure that the stipulations in the contract are being fulfilled. In most cases this would be accomplished with annual or seasonal site visits to make sure that the BMP is in place and is functioning effectively.

4.4.2 Water quality monitoring

In many cases, WQT programs are designed based on assumptions of nutrient loading and effectiveness of abatement practices. Monitoring water quality can help determine the effectiveness of the program, which can help refine the WQT program.

The design of a water quality monitoring program depends on several factors: overall monitoring objectives, data needs and available resources. Measurements conducted at the edge of fields at regular intervals and during rainfall events will provide important information on BMP effectiveness. Care should be taken when averaging sampling results, as parameters deviate significantly from longer-term averages after unusual events. For this reason, measurements taken for the express purpose of determining watershed responses to rainfall events must be excluded from average loading calculations (see **Appendix C** for information on parameters measured).

4.4.3 Watershed response monitoring

WQT systems are implemented to achieve stated water quality goals. In the case of the Lake Winnipeg Basin, the objective is to reduce nutrient loading to 1970s levels to improve recreation, and protect aquatic ecosystems (Lake Winnipeg Stewardship Board, 2006). Monitoring in this case would involve examining some of the adverse impacts associated with nutrient over-enrichment leading to algal blooms. Keeping track of the frequency of algal bloom events can assist in assessing

a WQT system's effectiveness. Other variables to monitor include: fisheries landings, wildlife populations, flood frequency and shoreline habitat health. Essentially, this is a monitoring of the variables that would indicate that the health of the lake is improving.

The Namao research vessel is a platform for biophysical research in Lake Winnipeg. The type of research being carried out on the aquatic biota, as well as water quality parameters, should continue to be researched, as the outcomes of successful nutrient loading reductions will be revealed at this level. The design of a watershed monitoring response program could be influenced by the comprehensive system in place for the Fraser River in British Columbia, which goes beyond water chemistry to track trends in indicator species (Bernard, et al., 1993). Some issues specifically identified for the Lake Winnipeg Basin include invasive species, hydrological influences of climate change, resource harvesting and industrial discharge (Lake Winnipeg Stewardship Board, 2006).

4.5 Economic aspects

Different pollution sources have different abatement costs, which is the motivation for WQT. Pollution sources may prefer to buy effluent permits rather than spending more to reduce their own effluent. WQT offers emission sources with low abatement costs opportunities to sell their excess reductions to higher cost emitters at a higher price than their reduction costs. In essence, market forces allow the desired environmental objective to be achieved at least cost.

Incorporating environmental externalities into a market system is the primary economic objective of emission trading. Monetarily valuing and commoditizing a pollutant provides the conditions required for it to be traded. Within the Lake Winnipeg Basin context, nutrients (phosphorus and nitrogen) should be commoditized in a WQT system as they are the main pollutants impacting water quality (Lake Winnipeg Stewardship Board, 2006; McCandless, et al., 2008; Schindler & Donahue, 2006).

Water quality objectives in the form of permissible loadings and existing buyers and sellers are required to provide the ideal WQT market conditions (Nolet, et al., 2008). In the case of Lake Winnipeg, a binding annual nutrient load cap needs to be established in consultation with point sources, as they will create the demand for emission permits. While point source emitters are the only entities subject to an emission cap, both point and nonpoint sources can generate tradable emission credits. Based on evidence from WQT programs in the United States, Ribaudo and Nickerson (2009) contends that nonpoint sources must account for 50 to 90 per cent of emissions to create ideal market conditions. If there are not enough point sources to create a demand for nutrient credits, a government agency or a large insurance company could act as a universal buyer. In this instance, public expenditure supporting the adoption of BMPs would have to shift towards the purchase of nutrient load credits. In the case of the Lake Winnipeg Basin, nonpoint sources account

for a significant portion of the nutrient load. Generating emissions credits from lowering nonpoint sources will likely be realized through the adoption of BMPs.

Implementing BMPs to improve water quality often leads to co-benefits through the additional provision of ecosystem goods and services (EGS).¹⁵ For instance, restoring wetlands provides a number of EGS, such as nutrient retention and absorption, wildlife habitat and carbon sequestration. No-till farming practices can prevent soil erosion and nutrient runoff and lower fertilizer requirements. It is essential to determine a BMP's value relative to the nutrient credits being traded. It may also be desirable to determine the values of related co-benefits, which may require the use of non-market based valuation methods (see **Appendix D**). While understanding the full value of BMPs may be useful, it may not be practical to do so within the context of a WQT program.

Box 1 - The Provision of Public Benefits from Agricultural Lands

Agricultural activities are carried out on a significant portion of the world's landscape and it is important to recognize the "multifunctional aspect of agriculture, particularly with regard to food security and sustainable development" ("Rio Declaration on Environment and Development," 1992). This suggests that farmland can provide multiple benefits, beyond the provision of food and fibre that usually have market values. Through careful management of the landscape, farming can also provide a variety of EGS, such as nutrient cycling and soil formation, flood regulation and water purification (Ruhl, 2008; Wilson, 2008). Agriculture also fosters cultural services, through the livelihoods developed in its pursuit. Society at large accrues the benefits of these services, while the costs are borne by farmers who are largely uncompensated.

There are several challenges that prevent institutional linkages between public EGS benefits and agricultural production. Virtually all agricultural land in Canada is privately held, and in most cases the landowners retain rights related to its management. The problem is that immediate on-farm costs can result in benefits both on and off the farm (i.e., to hunters and fishermen, downstream property owners, and society at large), while returns to the farm may be less discernable (Sampson, 1992). Considerable research has been carried out on the disconnect between public values and private land. The Nature Conservancy of Canada has funded and promoted comprehensive economic research related to the value of natural landscapes on the Canadian Prairies (Olewiler, 2004). Ducks Unlimited Canada has also made the linkage between wetland functions and watershed management (Yang, Wang, Gabor, Boychuk & Badiou, 2008).

¹⁵ Ecosystem goods and services (EGS) represent the benefits that human populations derive, directly or indirectly, from the healthy functioning of evolving ecosystems that encompass air, water, soil and biodiversity. This definition is wide-ranging, and includes all products derived from natural ecosystems (de Groot, Wilson & Boumans, 2002; Millennium Ecosystem Assessment, 2005).

Nonpoint sources credits generated from BMPs must be real, additional, verifiable, permanent and enforceable. For nonpoint source offsets to be additional, it must be demonstrated that they are in addition to regulatory requirements and are additional to what would have occurred without the incentive provided by the sale of the credit (Offset Quality Initiative, 2008).

The main barriers to BMP implementation are potential revenue losses via additional capital costs and potential loss of production. For example, a capital cost would arise if new equipment is required to institute a BMP such as zero-till. A loss of production would arise when a producer removes a field from agricultural production to restore a wetland. It is assumed that a farmer will implement a practice only when the sale value of the water quality credits generated matches the BMP implementation cost.¹⁶

Initiatives that enhance ecosystem services provide value to society. The conservation reserve program in the United States was deemed to produce water quality benefits of nearly US\$200/ha (Hansen & Ribaud, 2008). Using market-based mechanisms such as WQT has the potential to be even more cost effective by funding improvements that yield the greatest benefits.

4.6 Challenges and barriers

There are a number of challenges and potential barriers associated with the implementation of a WQT program. Recognizing these barriers during program design and implementation is an important step towards resolving them through adaptive learning and collaboration. This implies that cooperation between the potential trading entities within the Lake Winnipeg Basin is imperative to ensure the successful implementation of a WQT program. The challenges and barriers discussed in this section include developing a regulatory nutrient cap for the Lake Winnipeg, the non-homogenous nature of credits from nonpoint sources, the difficulties associated with monitoring nonpoint sources due to its diffuse nature and ensuring trading certainty and guaranteeing transaction terms for permit purchasers.

Developing a regulatory cap may be a substantial barrier to the implementation of a viable WQT system for the Lake Winnipeg Basin. The development of a regulatory cap must conform to a legislative development process, which includes analysis, public consultations, amendments and approval by cabinet. The inter-jurisdictional nature of the basin adds complexity to the development of new legislation. Our recommendations for the development of a basin-wide regulatory cap include building on federal acts to accommodate the development of such a basin-wide cap and process. The Canadian Environmental Protection Act and the Canada Water Act give us some tentative openings to accommodate such a regulatory cap. However, the enactment of such additions to long-standing processes within a decentralized and inter-jurisdictional region is

¹⁶ In this case we assume that there are no financial incentives to adopt the BMP in the first place.

challenging. In addition, existing water emission permit processes may impede the development of new legislation (see **Appendix F** on Manitoba Licenses).

The challenge of involving nutrient nonpoint sources in a WQT system is based in the non-fungibility¹⁷ of the nutrient reductions. Woodward et al. (2002) explain that WQT involving nonpoint sources usually only *estimate* the reduction in pollution achieved by a management practice. The actual pollution reduction will depend on the weather, a multitude of location-specific characteristics and how well the practice is implemented. Even within the same watershed, water pollution from two sources may have significantly different environmental impacts. WQT credits generated by nonpoint source reductions are non-homogeneous, making the development of a market exchange difficult without simplified and flexible protocols. In addition, difficulties in monitoring impacts and creating accurate mechanisms to facilitate trading between non-homogenous credits may encourage enforcement and management agencies (often governments) to turn to a system of buyer liability to facilitate enforcement.

The lack of clear, standardized and uniform nutrient data for the Lake Winnipeg Basin is another prominent challenge. Monitoring nonpoint sources is difficult as they enter receiving waters through unidentifiable flow paths, making it difficult to accurately assign accountability. For this reason, incorporating nonpoint source trading may lead to the following problems: expensive monitoring and enforcement costs; inaccurate and expensive load predictions; legal conflicts arising from discrepancies between estimated and actual reductions. Nevertheless, nonpoint sources are typically incorporated into a WQT system because their abatement costs are often significantly lower than point sources. They can also generate important socio-ecological co-benefits in a well-designed system. A planned monitoring framework to measure nutrient reductions at key monitoring points in the watershed will ensure that goals for nutrient reduction are met. The monitoring will allow for adaptive management of the trading program by adapting programming to enhance what works and eliminate or minimize what doesn't work.

Trading certainty and transaction guarantees is another obstacle to WQT. Ullo (2007) notes that standard contracts between buyers and sellers should identify trading parties involved, pollution abatement techniques, amount of credits being traded, effective dates of the trading period (start and end), price paid and payment terms. Contracts also provide certainty through the formalization of transaction costs. Martin (2007b) points out that simply purchasing credits does not provide protective rights for the purchaser or guarantee the terms of the transactions. This represents a major source of uncertainty for buyers and points to the value and importance of a system of trading support, certification, and verification. The use of trading ratios and pollution permitting is another way to “establish a foundation of trading certainty” for point source emitters, largely because these approaches have been identified by regulators as preferential (Farrow, Schultz, Celikkol & van

¹⁷ Fungibility describes the interchangeability of a good or commodity with a good or commodity of the same type.

Houtven, 2005). Roberts, et al. (2008) suggests that regulators and other government agencies should focus on helping point sources locate and contract with sellers versus establishing elaborate trading infrastructure.

5.0 Water Quality Trading for the Lake Winnipeg Basin: A Proposed Framework

The Lake Winnipeg Basin poses a significant inter-jurisdictional water quality management challenge. Overcoming this challenge will require novel approaches that can transcend provincial and international boundaries and regional management systems to develop and adopt a coherent and effective nutrient management plan. Our recommendations for developing a WQT framework for the Lake Winnipeg Basin is a step towards surmounting this challenge.

Despite the institutional complexities in creating a regulatory basis for nutrient trading, we remain convinced that the process involved in setting up a nutrient trading program will lead to water quality management improvements in the basin. To develop a water quality market framework, prevalent issues such as a lack of institutional capacity, nutrient discharge limits and coordinated regional planning compatible with basin objectives must be addressed. If these issues are dealt with effectively, implementing a WQT program can benefit the goal of integrated water resources management in the Lake Winnipeg Basin.

A number of considerations need to be taken into account when designing an efficient WQT program for the Lake Winnipeg Basin. Various levels of government will have to play important roles to adequately design the WQT program. A reliable monitoring system will be required to track water quality to ensure that it is being improved and that trading rules are being observed. Established sanctions will provide a means to enforce the trading rules. The market type for the WQT program may need to be phased from bilateral agreements to a clearinghouse and eventually an exchange. A sufficient number of trading partners will be required to provide a broad range of abatement costs and ensure cost effectiveness. WQT transaction costs could potentially be high for a basin the size of Lake Winnipeg and efforts should be made to minimize them. Some of these design considerations will be discussed for the Lake Winnipeg Basin context.

The WQT architecture proposed for the Lake Winnipeg Basin was designed based on the objective of reducing nutrient loads flowing into Lake Winnipeg so that its water quality can be improved cost effectively. The basin trading architecture proposed is based on an inter-trading system between the major sub-basins. Each sub-basin measures and aggregates net nutrient discharges to participate in the nutrient trading system as a buyer, seller or nutrient neutral entity. Under this framework, the sub-basin authority would act as the nutrient credit aggregator to facilitate trading with the other sub-basins.

The WQT system proposed is flexible and could include the entire basin or focus on sub-basins contributing the majority of the nutrient load. Nutrient loads from nonpoint sources account for a good portion of the overall load flowing into the lake. Therefore making allowances for point-to-point and point-to-nonpoint source trading is preferential. Modelling efforts (AAFC WEBs and Environment Canada Lake Winnipeg modeling projects) are underway to understand the lake's responses to nutrient loads and nutrient transport mechanisms on the landscape and water bodies.

5.1 The biophysical structure

The WQT architecture proposed is motivated by the goal of improving the water quality of Lake Winnipeg. A multi-level trading system is proposed due to the Lake Winnipeg Basin's vast geographic expanse and multi-jurisdictional nature. There are two main elements to the biophysical structure proposed. The first consists of establishing inter-trading opportunities between the major sub-basins of Lake Winnipeg by applying a modified version of the trading ratio model (see **Appendix B**). The second consists of establishing intra-trading opportunities within the major sub-basins by identifying nutrient emission point and nonpoint sources and applying a trading ratio model at the sub-basin scale. **Figure 13** shows the multi-level architecture proposed, which refers to the reverse auction program that can be used to aggregate nutrient credits at the sub-basin or watershed levels.



Figure 13: Conceptual representation of a multi-level trading system for the Lake Winnipeg Basin

This multi-level WQT architecture provides flexibility for trading to occur at various basin or watershed spatial scales. The major sub-basins are being proposed as the largest spatial scale where nutrient emissions from point and nonpoint nutrient sources are aggregated to allow for point to

point source trading between the major sub-basins of the Lake Winnipeg Basin. In this way, nested WQT systems can evolve simultaneously to achieve local water quality objectives and an overall nutrient reduction goal for the Lake Winnipeg.

5.1.1 Inter sub-basin trading

The proposed Inter Sub-Basin Trading architecture is based on the trading ratio model, which uses emission zones to establish zonal caps and tradable permits (see **Appendix B**). The Lake Winnipeg Inter Sub-Basin Trading model defines its zones as the sub-basins that discharge their water into the main rivers flowing into Lake Winnipeg (see **Figure 14**). Dispersion coefficients are calculated to determine the sub-basin nutrient emission impacts on the lake and corresponding impact trading ratios for the proposed inter sub-basin trading system. The steps required to establish an inter sub-basin trading system are the following:

1. The Lake Winnipeg's sub-basins are mapped and their outflows identified, which corresponds to the number of trading zones within the inter sub-basin trading system (see **Figure 14** and **15**). Nutrient loads are monitored at each outflow point identified on the map. It must be noted that the rivers on the east side of the Lake Winnipeg have been combined as one zone and that the Bloodvein River is being proposed as their monitoring proxy due to the similar undisturbed landscape that they drain. The Bigstick Lake and the United States portion of the Lower Red River sub-basins have two monitoring points that can be treated as single or separate trading entities.

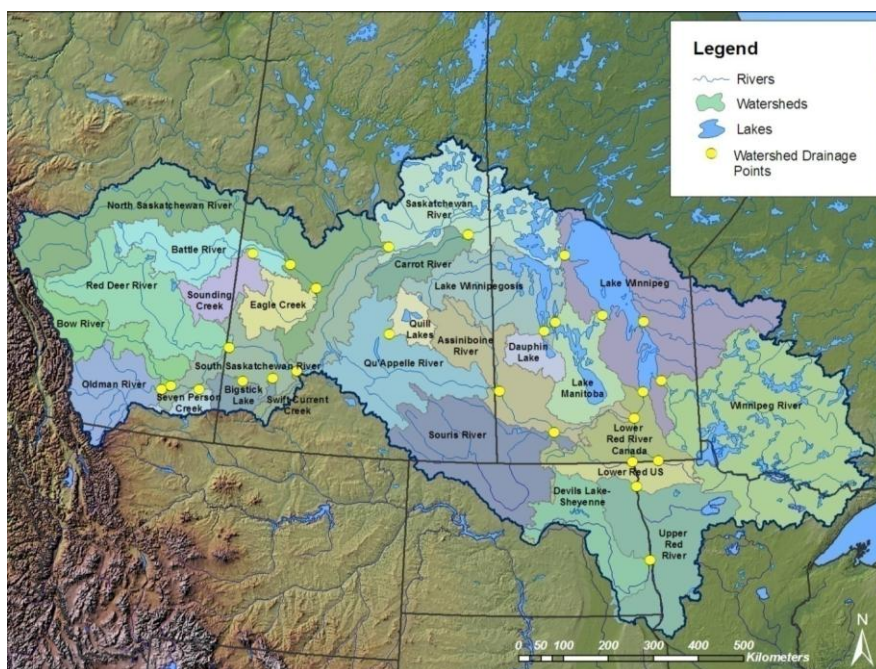

Figure 14: Lake Winnipeg watershed monitoring network and trading zones

2. A total phosphorus load target is established for the lake and is divided into the six main stems feeding the lake (see **equation 1** below). The load allocations amongst the main stems will likely be based on historical loads.
3. Dispersion coefficients are then calculated for each sub-basin outflow and point source on the main stems. The dispersion coefficient is a point-to-point nutrient delivery measure that must be accurately estimated as it is the impact trading ratio between entities in the Lake Winnipeg Basin. For example, the dispersion coefficient from point X to Y is equal to 0.4 if for every kilogram of nutrient emitted at point X only 0.4 kg reaches point Y. The dispersion coefficients are estimated using monitored nutrient loads and water pollution transport modelling equations.
4. Nutrient emission loads from each trading zone within the river network are measured and multiplied by their respective dispersion coefficient to measure their impact at the point of entry into the lake. The sum of the nutrient load emissions from all the trading zones within a main stem cannot exceed its loading allocations (see **equation 2**). Load allocations can then be established for each trading zone within the Lake Winnipeg Basin using the dispersion coefficients (see **equation 3**).
5. Actual nutrient loads monitored at each trading zone are compared to their allocations to identify if they can sell or must buy emission permits. The difference between the actual and allocated nutrient load emissions at each trading zone determines the number of permits that a trading zone can buy or sell (see **equations 4, 5 and 6**).

$$1. L \leq \sum_{i=1}^6 S_i$$

$L =$ total lake load

$S_i =$ phosphorus load for river i

$E_{ij} =$ phosphorus load at river i trading zone j

$t_{ij} =$ dispersion coefficient (river i trading zone j)

$D_{ij} =$ phosphorus load delivery at the lake from river i trading zone j

$T_{ij} =$ load allocation river i trading zone j

$i =$ river label

$j =$ trading zone label

$$2. S_i \leq \sum_{j=1}^n E_{ij} \times t_{ij}$$

$$3. D_{ij} = E_{ij} \times t_{ij}$$

$$4. E_{ij} < T_{ij} = \text{permit seller}$$

$$5. E_{ij} > T_{ij} = \text{permit buyer}$$

$$6. E_{ij} - T_{ij} = \pm \text{permits}$$

Trading between sub-basins will require facilitation by an institution with oversight over the entire Lake Winnipeg Basin (such as the Provincial Prairie Water Board or the Agri-Environmental Service Branch).

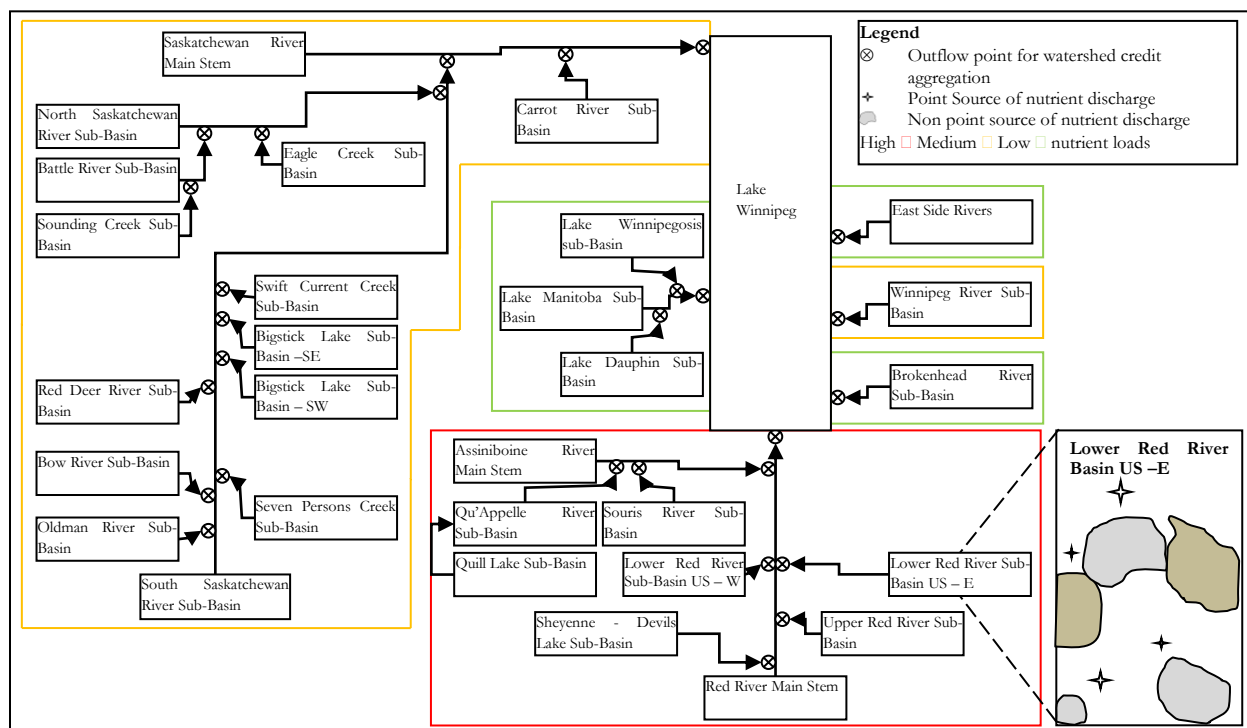

Figure 15: Conceptual representation of a multi-level trading system for the Lake Winnipeg Watershed

5.1.2 Intra sub-basin trading

The second biophysical structural element consists of establishing an intra sub-basin trading system to lower nutrient loads at the outflows of the sub-basins. Lowering the monitored nutrient load below the sub-basin cap will provide the sub-basins trading entity with credits to trade at the inter sub-basin level. This is aligned with a nested sub-basin approach prescribed by the general principles of integrated water resources management.¹⁸ The sub-basin trading institutions responsible for inter sub-basin trading would be ideally placed to manage internal trading between point and nonpoint sources within their respective sub-basins.

¹⁸ Integrated water resources management is “a process which promotes the co-ordinated development and management of water, land and related resources on a watershed basis in order to maximize the resultant economic, social welfare in an equitable manner without compromising the sustainability of vital ecosystems” (Torkil, 2004, p. 14). Watershed management builds on the concept of the ecosystem and recognizes their nested, hierarchical structure.

To establish an inter sub-basin trading system, the various point and nonpoint nutrient sources within the major sub-basins must be determined. Identifying large point sources is straightforward as they are likely regulated and monitored. These will most likely include municipalities, industry and intensive livestock operations. Nonpoint sources, on the other hand, are harder to identify and quantify and may require a substantial amount of biophysical data to understand how these diffuse emissions sources are transported into water bodies. These will include agricultural runoff and urban runoff from road and stream bank erosion.

The intra sub-basin trading system can be designed in a number of ways. Sub-basin cap and trade systems, basin-wide point-to-point source trading with nonpoint source trading provisions and EcoTender program (see **Box 2**), are a few examples of WQT designs that can be adopted to establish an intra sub-basin system. The trading systems adopted by each basin can vary to fit specific contexts. Within the Lake Winnipeg Basin context, including nonpoint sources will be beneficial as they account for a large fraction of the nutrient load and could lower the costs of water quality improvement. The goal is to implement adequate WQT mechanisms within each sub-basin so that their emission caps are respected.

Box 2 - The Reverse Auction Concept and Water Quality Trading

Reverse auctions are market-based instruments designed to procure improved environmental outcomes at least cost. Financial incentives are provided by public institutions to landowners who then compete with one another to adopt land-use changes and management practices that enhance natural environments. This process allows for investments in the most cost-effective environmental improvements and can be targeted at single or multiple environmental targets. Avoiding price collusion among landowners is a key issue for a successful reverse auction program, and can be mitigated by evaluating rival bids with an integrated assessment model as is the case with the Australian EcoTender approach.

Reverse auctions could provide an effective way to initiate and manage intra-watershed WQT. “Reverse auctions are well suited for allocating funding in both conservation programs and environmental trading markets where a single buyer buys a number of ecosystem services from many sellers” (Greenhalgh, Guiling, Selman & St. John, 2007, p. 2). The model was first tested successfully in parts of Northern Victoria, Australia. Local farmers were involved in a competitive bidding process to access AU\$500,000 allocated by the state for ecosystem enhancement projects.

The reverse auction concept, such as the Australian EcoTender program, can be viewed as a sub-set of WQT whereby there is only one buyer and multiple nonpoint sellers. The main advantage of the reverse auction is that the bidding process reveals the opportunity cost of nonpoint source BMPs and offers greater assurance that investments are least cost. A second advantage of the reverse

auction system is that it can be generalized for multiple environmental objectives, such as been done with EcoTender. For example, if two rival nonpoint source BMP bids had equivalent nutrient reduction performance and equivalent cost, but one had superior habitat and flood protection co-benefits when evaluated with an integrated assessment tool, that bid would be selected. For example, the EcoTender program applied in Australia had four objectives: enhancing terrestrial biodiversity, rehabilitating aquatic functions, reducing salinity and sequestering carbon (Mark Eigenraam, Strappazon, Landsdell, Beverly & Stoneham, 2006; Mark Eigenraam, Strappazon, Lansdell, et al., 2006). Proposals submitted by bidders were valued by weighing the environmental objectives simultaneously (Eigenraam, Strappazon, Landsdell, Ha, et al., 2006).

The first step in establishing a reverse auction program consists of communicating the scheme to local landholders to gauge interest. Interested participants that meet a general set of criteria are registered. Site assessments are conducted by the state on their lands to determine the environmental benefits that could be achieved from specific actions or projects. The landowners are then provided with a list of potential actions that they could undertake which would result in specific environmental outcomes. This provides them with the required information to submit bids to the State that specify the actions they will undertake and their anticipated costs. The bids submitted will have a wide range of cost efficiencies due to differences in location, environmental effectiveness and BMP implementation costs within the watershed. The bids are reviewed by the state and assessed based on the environmental benefit of the action divided by the cost. The state chooses to fund the most cost-effective projects.

The World Resource Institute makes the following general recommendations when designing and implementing a reverse auction system (Greenhalgh, et al., 2007):

- Ensure that all prospective bidders clearly understand the goal of the reverse auction.
- Keep the system as simple as possible to ensure highest participation.
- Use adequate methods to estimate environmental outcomes and BMP implementation costs to ensure that the bids are relatively comparable.
- Ensure that all tools used to implement the reverse auction system are user friendly.
- Clearly define the rules of the auction to avoid confusion.

The Australian EcoTender model uses the Catchment Modeling Framework (CMF) to assess the potential benefits of adopting BMPs on private lands. The CMF consists of a suite of systems models that combine biophysical information to assess environmental outcomes in a systematic manner. It can estimate the environmental outcomes of various BMPs and represent them spatially to potential bidders and purchasers of the services.

Developing a reverse auction model for the Canadian Prairies could enhance intra-basin WQT where regulated sources are limited. The regulated sources could issue tenders for landowners to undertake BMPs that improve water quality and provide co-benefits such as carbon sequestration and biodiversity enhancements.

The watershed-level nutrient aggregations are considered point sources of nutrient loads and are treated as such through a regulatory cap at the basin level. Watershed level “aggregators” are responsible for internal negotiations between point and nonpoint sources *within* the watershed. The net resultant nutrient, if under the basin regulatory cap, is a nutrient credit, and if over the regulatory cap is a nutrient deficit. Trading between watershed aggregators is facilitated through these watershed agencies with oversight, monitoring and verification of credits being undertaken by a larger entity.

5.2 The institutional structure

A key component of WQT and its implementation success is the capacity of participating and management entities within the watershed. The agencies within the Lake Winnipeg Basin (federal/regional, provincial and watershed level entities) that could satisfy various WQT roles are examined by assessing their current mandate, function and capacity. For example inter-jurisdictional agencies, such as PPWB and Agri-Environment Services Branch (AESB), as well as provincial entities, may play important integration roles with respect to monitoring, verification and regulatory WQT requirements.

A clear relationship does not exist between the jurisdictions of the agencies examined and the inter and intra sub-basin-based WQT system proposed for the Lake Winnipeg basin. Nevertheless, overlaps are highlighted and it is proposed that future alignments be strengthened between institutional capacity and these sub-basins. Jurisdictional challenges may be overcome by engaging existing sub-basin and watershed based agencies. In addition the establishment of WQT programs could incent the formation of agencies with the geographical scope required to adequately administer and manage the program.

5.2.1 Federal/regional agencies

Environment Canada has committed to remediating the water quality of the Lake Winnipeg and has five goals for this purpose: reduce blue-green algae, ensure fewer beach closures, keep in place a sustainable fishery, provide a clean lake for recreation and restore the ecological integrity of the lake (Environment Canada, 2008a). Environment Canada is a potential agency to take the lead on the development of a basin-level strategy, overall management, enforcement, monitoring and reporting for the WQT system.

The **Agri-Environment Services Branch (AESB)**, a branch of AAFC, has a unique federal water management mandate. Its projects have ranged broadly from human resettlement in drought-stricken areas, infrastructure developments, land-use improvements and geographic information systems for agriculture (Corkal & Adkins, 2008). The AESB, with its agro-environmental management mandate, along with partners from provincial departments responsible for agriculture and water resources management, is well-suited to manage and enforce a WQT program in the Lake Winnipeg Basin.

The **Prairie Provinces Water Board (PPWB)** provides oversight on the Master Agreement on Apportionment based on the principle of equitable sharing of available Prairie water resources” (Prairie Provinces Water Board, n.d.). Apart from overseeing water quantity allocations, the PPWB is also responsible for the maintenance of acceptable water quality levels at the interprovincial boundaries (Prairie Provinces Water Board, Undated). While the existing water quality monitoring objectives are only applicable to the Alberta-Saskatchewan and the Saskatchewan-Manitoba borders, an extension of these objectives to the Ontario-Manitoba border could serve as the basis for the Canadian portion of the WQT monitoring framework within the Lake Winnipeg Basin.

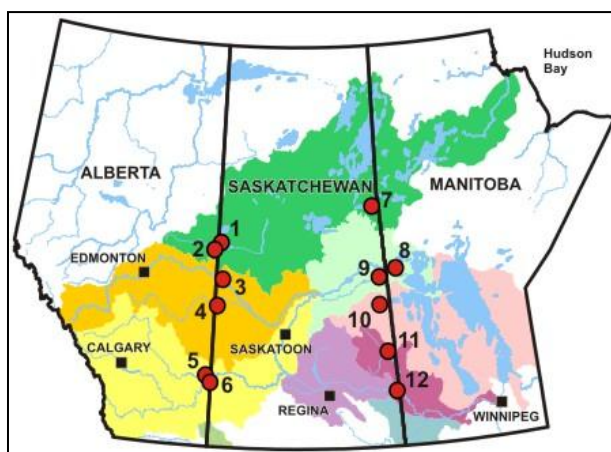

Figure 16: Water quality monitoring locations administered by the Prairie Provinces Water Board (Environment Canada, 2008b)

Ducks Unlimited Canada (DUC) is a national, non-profit organization with a significant prairie presence in the context of wetland conservation and restoration, as well as habitat conservation and management. They have had an increasing role and influence in watershed-based management and conservation in the Prairie provinces with some prominence in Saskatchewan. DUC have extensive technical expertise in natural habitat conservation and restoration. Specifically, they have extensive experience in remote sensing GIS mapping within the Canadian Prairies. Their technical capacity in the field of ecology and remote sensing could be leveraged to facilitate WQT with nonpoint sources.

DUC could also potentially be involved in purchasing credits and monitoring and verification of nonpoint source mitigation projects.

Nature Conservancy of Canada (NCC) is a national organization working on the conservation of ecologically significant lands and habitat, largely through research, planning and institutionalizing conservation easements. They are an important advocate for the conservation of natural environments and their research and expertise could be leveraged to ensure that BMPs are implemented effectively. The NCC could potentially fill the role of monitoring and verification of BMPs and their water quality improvements across the Lake Winnipeg Basin.

5.2.2 Provincial agencies

The **Alberta Water Council**, established in 2004, is a multi-stakeholder partnership with 24 members from governments, industry and non-government organizations. Its primary task is to monitor and steward implementation of Alberta's *Water for Life* strategy for safe and secure drinking water supply, healthy aquatic ecosystems, and reliable, quality water supplies for a sustainable economy (Alberta Water Council, 2004). The Alberta Water Council could potentially represent the province's interest in an inter-jurisdictional committee for design and oversight of the WQT framework.

The **Saskatchewan Watershed Authority (SWA)** is currently responsible for managing water infrastructure, monitoring quality and quantity of ground and surface waters, providing flood forecasting and identifying vulnerable areas, undertaking watershed studies and evaluations, promoting efficient water use, providing approval of construction and maintenance of drainage works, managing and conserving watersheds and fish habitat and providing assistance for erosion control and maintenance of water control works. Saskatchewan has an evolved framework for watershed management and is the first province to produce a "State of the Watershed Report Card." It is also further ahead in piloting economic incentives for watershed-based goods and services. The reverse auctions methodology piloted by SWA in partnership with Ducks Unlimited Canada in the Assiniboine River Watershed (Agriculture and Agri-Food Canada, 2008), and the Lower Souris EGS pilot (Saskatchewan Watershed Authority, 2009) with funding from Agriculture And Agri-Food Canada's ACAAF (Advancing Canadian Agriculture and Food) fund are examples of such initiatives in Saskatchewan. The SWA can provide provincial water quality management expertise, which must be represented in the design of the WQT system.

The **Manitoba Agricultural Services Corporation (MASC)** is a potential candidate for provision of technical, programmatic and economic exchange assistance. It is currently responsible for delivering agricultural insurance and credit programs to producers.

The **Manitoba Habitat Heritage Corporation** (MHHC) is a non-profit crown corporation established to “conserve, restore and enhance fish and wildlife habitat.” The MHHC conserves habitat by working in partnership with private landowners, farm organizations, corporations, conservation groups and government agencies. MHHC focuses on agricultural regions of the province, to promote conservation practices that not only benefit habitat, but also help sustain farm family income and productive use of land. The MHHC board has representation from provincial departments of water, agriculture, federal department of environment, NGOs such as DUC and Delta Waterfowl foundation, as well from producer and local groups such as Keystone Agricultural Producers, Association of Manitoba Municipalities, Manitoba Conservation Districts Association and citizen representation.

Lake Winnipeg Stewardship Board (LWSB) was set up in 2003 to identify and assist in implementing actions to reduce nutrient to pre-1970s levels in Lake Winnipeg (Lake Winnipeg Stewardship Board, 2006). The board comprises of multi-stakeholder representation, including relevant federal government agencies, provincial government agencies, municipal government agencies, academics, scientists, fisher-people, farmers, industry, consulting and First Nations. In December 2006, the LWSB produced a series of recommendations for improving the water quality of Lake Winnipeg. The LWSB received an expanded terms of reference from the Province of Manitoba to set up lake quality goals and produce state-of-the-lake reports. This agency is one of the few agencies with Lake Winnipeg management as its key goal. Manitoba is the only province represented within the LWSB and expanding the scope and representation on this board could allow it to take on the role of the basin WQT aggregator and regulator.

5.2.3 Watershed-level entities

Relevant watershed credit aggregators in the provinces of the Lake Winnipeg basin include the Alberta Watershed Planning and Advisory Committees (WPAC), Saskatchewan Watershed Advisory Committees (WAC), Manitoba Conservation Districts (CD) and Ontario Conservation Authorities (CA).

Alberta WPAC: North Saskatchewan Watershed Alliance, Red Deer River Watershed Alliance, Bow River Basin Council and Old Man Watershed Council.

Saskatchewan WAC: North Saskatchewan River Watershed Advisory Committee, South Saskatchewan River Watershed Advisory Committee, Upper Qu’Appelle River Watershed Advisory Committee, Assiniboine River Watershed Advisory Committee, Moose Jaw River Watershed Advisory Committee and Lower Souris River Watershed Advisory Committee.

Manitoba CD: Swan Lake CD, Lake of the Prairies CD, Intermountain CD, Alonsa CD, Upper

Assiniboine River CD, Little Saskatchewan River CD, Turtle River CD, Whitemud CD, West Souris River CD, Assiniboine Hills CD, Pembina Valley CD, La-Salle-Redboine CD, West Interlake Watershed CD, East Interlake CD, Seine-Rat River CD, Turtle Mountain CD and Cooks Creek CD.

There are currently no relevant Ontario CAs.

Table 6 provides a synthesis of the current and potential roles and functions that the agencies presented above could take on.

Table 6: Potential roles of the agencies within the Lake Winnipeg Basin WQT system

Role	Function	Recommended agencies for role
Buyers	Buyers of credits to fulfill requirement under a regional or basin-wide regulatory cap. While intra-basin buyers would include municipalities, industries, hydro agencies, large livestock operators and watershed or regional aggregators, under our inter-basin trading plan, buyers would be those watersheds that exceed their allowable nutrient discharge limit under the regulatory cap.	Watershed agencies such as Alberta WPACs, Saskatchewan WACs, Manitoba CDs and Ontario CAs.
Sellers	Under our framework, watershed level credits or allowances would be aggregated by watershed agencies.	Watershed agencies such as Alberta WPACs, Saskatchewan WACs, Manitoba CDs and Ontario CAs.
Regulators	An inter-jurisdictional entity with stakeholder representation and regulatory power.	We see this stakeholder board having representation from Environment Canada, AAFC (possibly AESB), and the four provincial governments. Some additional representation may be required from Lake Winnipeg - such as the Lake Winnipeg Stewardship Board.
Credit Exchangers	Normally considered a discrete role, this role could be easily overlapped with our watershed-level aggregators.	Nutrient credits may be aggregated at the watershed level by watershed level organizations such as WPACs, WAs, CDs and CAs. Alternately, a quasi provincial agency can be provincial-level aggregator for inter-provincial trades. The Manitoba Habitat Heritage Corporation and Manitoba Agricultural Services Corporation are examples of such agencies in Manitoba.
Financial and Technical Services Providers	Analysis and recommendations for adaptive management of WQT design and implementation.	Relevant federal and provincial branches of policy and management, as well as relevant policy research organizations and NGOs such as DUC, IISD, Delta Waterfowl and MASC.
Monitoring and Verification	An agency that takes responsibility for the outcome monitoring and informing adaptive	Prairie Provinces Water Board, as an extension of their current functions of

	management of the trading platform and requirements.	water quantity and quality monitoring at the provincial borders. Other potential candidates include Ducks Unlimited Canada and the Nature Conservancy of Canada.
--	--	--

5.3 The market structure

Our overall architecture of inter sub-basin credit trading, using aggregated credits at the sub-basin level, combined with intra sub-basin trading between point and nonpoint pollutant sources builds on the composite market model. The composite market disaggregates permit transactions into two primary markets and one secondary market. It combines characteristics of both the exchange and the clearinghouse structures. The two primary markets serve as a clearinghouse for sellers of performance contracts and buyers of discharge permits. This market system reduces the information transaction costs for individual sources.

Setting up a primary market begins with an estimation of the supply curve for abatement measures in the catchment area to be used for setting permit prices. Since an initial estimate can be adjusted as new information becomes available, this first estimation does not need to be comprehensive. This facilitates the use of partial information and justifies making preliminary estimates of abatement costs based on existing programs. The secondary market, like an exchange, is “characterized by its open information structure and fluid transactions between buyers and seller” (Woodward, et al., 2002, p. 375). The public availability of information about market clearing prices ensures that information transactions costs are minimal. The liquidity of this market also makes it easy for actors to enter into and get out of transactions, reducing the uncertainty of taking a position in the market.

Markets that are independent but linked and coordinated as integrated components of a composite market can achieve higher levels of efficiency if the costs of coordination are lower than the efficiency gains from serving targeted functions. Low information transaction costs are of particular importance at early stages of market development when market liquidity (thin markets) can lead to problems with the reliability of market price information and hinder the establishment of a viable transferable discharge permit market. Coordination in the composite market system consists primarily of the flow of price information between the three markets. Setting the price for permits is the function of the first market, the primary contract market.

It must also be noted that the market structure must also dictate the time period within which point and nonpoint source credits should be eligible. In the United States, any point source emission credits must be used when discharges occur (Martin, 2007b). Ullo (2007) notes that in Idaho, the use of nonpoint source credits must occur in the same month as point source discharges, which fits a model based on monthly self-reporting of point source discharges. It may be appropriate to use an

annual period for allowance/credit trading for the Lake Winnipeg Basin due to the expanse of its drainage area.

6.0 Conclusion and Recommendations

Water Quality Trading (WQT) is proposed as a means to remediate Lake Winnipeg, which has become the most eutrophied large lake in the world. Implemented with some success internationally, WQT harnesses the “power of markets” to remediate water resources cost-effectively. It is also suitable for lowering nutrient loads originating from diffuse nonpoint sources that cannot be effectively addressed via regulatory approaches. WQT systems are complementary and provide flexibility within a regulatory framework to lower nutrient loads in a cost-effective manner.

The Lake Winnipeg Basin is a suitable context to apply WQT, as the lake receives approximately 59 to 97 per cent of its overall nutrient load from nonpoint sources.¹⁹ This range is compatible with Ribaudo and Nickerson’s (2009) research, which maintains that nutrient trading between point and nonpoint sources can be feasible when the agricultural load contribution ranges between 50 to 90 per cent. Agricultural producers could have an important role within a WQT system for the basin as suppliers of nutrient load credits via the adoption of best management practices (BMPs). Reducing nonpoint sources by implementing BMPs also allows for the provision of co-benefits such as carbon sequestration, flood protection and wildlife habitats. Similarly to organic certification for agricultural goods, nutrient load credits offering co-benefits could be identified, marketed and potentially command a greater demand within a WQT marketplace.

This research presents a general WQT architecture for the Lake Winnipeg Basin, which consists of multi-level trading that would occur between and within sub-basins to cost effectively reduce phosphorus nutrient loads. Where there is one buyer and multiple nonpoint sellers, reverse auctions may be effective to facilitate intra sub-basin nutrient trading. A regulatory framework based on the Canadian Environmental Protection Act or the Canada Water Act could be used to implement WQT within the basin. Environment Canada and AAFC’s Agriculture Environment Services Branch could provide the institutional support to implement a WQT within the basin. A composite market is best suited for the Lake Winnipeg Basin WQT system as it can reduce transaction costs for individual sources. We propose the following steps to establish a WQT in the Lake Winnipeg Basin:

1. **Develop a total nutrient load (TNL) framework for the Lake Winnipeg Basin, based on the nutrient carrying capacity of the sub-basins and watersheds.** A total nutrient

¹⁹ Diffuse emissions from croplands range between 1,851 to 33,191 tonnes of phosphorus per year (cropland phosphorus emissions were estimated by multiplying emission coefficients [0.07 to 1.27 kg of phosphorus /year/hectare, (Belcher, et al., 2001) with total cropland area [26.14 million hectare]). Point source emissions from industrial and municipal wastewater point sources range between 955 to 1,128 tonnes of phosphorus per year. (Point source phosphorus loads were estimated based on National Pollutant Release Inventory (Environment Canada, 2007) and Municipal Water and Wastewater Survey data (Environment Canada, 2006). Smaller point source phosphorus loads were estimated based on a methodology developed by Chambers et al. (2001)).

loading framework would outline the requirements for examining and monitoring the condition of water bodies and guide modifications in related actions to improve water quality in upstream drainage systems. The ultimate focus of a TNL framework would be to understand and address changes in the health of contributing land bases and water bodies. Monitoring data from the four provinces would have to be assimilated and monitoring gaps would have to be identified and filled for adaptive management of the TNL framework for the future. The TNL will also provide the basis for trading ratios for inter-basin trades.

2. **Develop total nutrient loading framework for component watersheds as the basis for trading ratios for inter-basin trades.** The TNL must be established on the basis of biophysical parameters (carrying capacity, hydrology, land-use and land cover). In the absence of such synthesis, reduction caps aligned with regional recommendations are proposed as preliminary interim reduction targets for watersheds within the basin.
3. **Develop a regulatory limit on nutrient discharges based on the TNL framework and establish actions and timelines to meet limits.** A regulatory framework can apply regulatory limits on point source dischargers of nutrients and pollutants or limits on both nonpoint and point sources of nutrients. Based on a required flexibility within regulations, these limits can be achieved by a variety of means, including the use of technology and the use of tradable credits or allowances to offset discharges higher than the allowable limit with discharges well within the allowable limit. The Canadian Environmental Protection Act, Canada Water Act and the Canadian Environmental Assessment Act provide the federal bases for establishing a regulatory cap within the Lake Winnipeg Basin and sub-basins.
4. **Determine necessary institutional entities and capacity to allow nutrient credit trading.** While we have begun the steps of identifying relevant agencies and proposing matching roles for institutional entities within the basin, a thorough analysis of these entities, including their technical and financial capacity, is imperative for the design of an effective WQT framework. Recognizing the institutional and regulatory barriers to setting up a WQT framework, we suggest a “universal buyer” (most likely a government agency or a group of government agencies) as an interim measure to instigate the nutrient trading market. The universal buyer concept would help set up the market, get sellers and other stakeholders used to the idea of buying and selling nutrient credits, and address the challenges that initial sales might experience. A universal buyer system is therefore suggested for a pilot WQT platform within the Lake Winnipeg context.
5. **Assign roles and responsibilities for a working watershed market structure including aggregator, monitoring authority, verifier, regulator, communicator, buyers and sellers.** Communicate information about regulatory obligations and trading options to

stakeholders. A clear understanding of the ability to “trade” nutrient discharge allowances and credits is primordial to the successful implementation of nutrient trading. Regulatory caps, trading rules, required trading ratios, credit costs, contractual processes and obligations, etc. are clarified and communicated to the relevant stakeholders.

Implementing WQT within the Lake Winnipeg Basin to lower phosphorus nutrient loads would support the implementation of **Growing Forward: The New Agricultural Policy Framework**, which has provisions for funding producers to implement BMPs that protect water quality. WQT offers a real potential to remediate the water quality of Lake Winnipeg while allowing farming operations to thrive alongside healthy environments and water bodies that are imperative to the long-term sustainability of the basin.

Reference List

- Adamson, D., Mallawaarachchi, T. & Quiggin, J. (2007). Water use and salinity in the Murray-Darling Basin: A state-contingent model. *The Australian Journal of Agricultural and Resource Economics*, 51, 263-281.
- Agriculture and Agri-Food Canada. (2006). Census of Agriculture Data. Retrieved September 3, 2009, from ftp://ftp.agr.gc.ca/pub/outgoing/nlwis-lc/CEN_CA_AG_INTRP/DataTables/
- Agriculture and Agri-Food Canada. (2007). Watershed Evaluation of Beneficial Management Practices (WEBs). Retrieved August 15, 2009, from <http://www4.agr.gc.ca/AAFC-AAC/display-afficher.do?id=1185217272386&lang=eng#seven>
- Agriculture and Agri-Food Canada. (2008). Summary of Approved Ecological Goods and Services Pilot Projects. Retrieved August 15, 2009, from <http://www.landstewardship.org/List%20of%20AAFC%20Approved%20EGS%20Pilots.pdf>
- Alberta Water Council. (2004). Welcome to Alberta Water Council. Retrieved March 7, 2009, from <http://www.albertawatercouncil.ca/>
- Armstrong, N. (2006, October 18-19). *Nutrients in Lake Winnipeg Part One: Long term trends and nutrient sources*. Paper presented at the Canadian Water Resources Association Conference, Winnipeg, MB.
- Arnold, J. G., Williams, J. R. & Maidment, D. R. (1995). A Continuous Water and Sediment Routing Model for Large Basins. *American Journal of Civil Engineers Journal of Hydraulic Engineering*, 12(2), 171-183.
- Bateman, I. J., Lovett, A. A. & Brainard, J. S. (2003). *Applied Environmental Economics*. Cambridge: Cambridge University Press.
- Beare, S., Heaney, A. & Mues, C. (2001). *Modeling salinity management options in the Murray Darling Basin*. Paper presented at the New South Wales Agriculture and Department of Land and Water Conservation Salinity Economics Workshop.
- Belcher, K., Edwards, C. K. & Gray, B. (2001). *Ecological Fiscal Reform and Agricultural Landscapes - Annex 2c: National Round Table on the Economy and the Environment*.

Bernard, D. P., Marmorek, D. R., Berry, T. M., Paine, M., Perrin, C. J. & Richardson, J. (1993). *Fraser River Basin Assessment Program: Conceptual Monitoring Design*. North Vancouver, B.C.: Conservation and Protection Service - Environment Canada.

Beverly, C., Littleboy, M., Morris, J., Jones, R., Southwell, A., Sands, P., et al. (2007). *Technical Manual - Models of the Catchment Analysis Tool (CAT1D Version 22)*: The State of Victoria - Department of Sustainability and Environment.

Bockstael, N. A., Freeman, A. M., Kopp, R. J., Portney, P. R. & Smith, V. K. (2000). On Measuring Economic Values for Nature. *Environmental Science and Technology*, 34(3), 1384-1389.

Borisova, T., Blunk Saacke, K., Abdalla, C. & Parker, D. (2007, January 28 - February 1). *Comparative Analysis of Water Quality Credit Trading Programs and Projects in Mid-Atlantic States*. Paper presented at the USDA-C SREES National Water Quality Conference, Savannah, Georgia.

Bourne, A., Armstrong, N. & Jones, G. (2002). *A Preliminary Estimate of Total Nitrogen and Total Phosphorus Loading to Streams in Manitoba, Canada*. Retrieved from www.riparianhealth.ca/pdfs/mbcon_prelimEstimate.pdf

Breetz, H. L., Fisher-Vanden, K., Garzon, L., Hannah, J., Kailin, K. & Terry, R. (2004). *Water Quality Trading and Offset Initiatives in the U.S.: A Comprehensive Survey*. Hanover, New Hampshire: Dartmouth College, US Environmental Protection Agency.

Brouwer, R. (2000). Environmental Value Transfer: State of the Art and Future Projects. *Ecological Economics*, 32, 137-152.

Chambers, B., Garwood, T. W. G. & Unwin, R. J. (2000). Controlling soil water erosion and phosphorus losses from arable land in England and Wales. *Journal of Environmental Quality* 29, 145-150.

Chambers, P. A., Guy, M., Roberts, E. S., Charlton, M. N., Gagnon, C., Grove, G., et al. (2001). *Nutrients and Their Impact on the Canadian Environment*. Hull, Quebec: Agriculture and Agri-Food Canada, Environment Canada, Fisheries and Oceans Canada, Health Canada, Natural Resources Canada.

Chesapeake Bay Program. (2008, August 1, 2008). Maps - Bay Watershed. Retrieved February 12, 2009, from <http://www.chesapeakebay.net/maps.aspx?menuitem=16825>

Collentine, D. (2005). Phase-In of Nonpoint Sources in a Transferable Discharge Permit System for Water Quality Mangement: Setting Permit Prices. [Towards More Integrated Water Resources Management]. *Ambio*, 34(7), 573-578.

Copeland, C. (2001). *Clean Water Act and Total Maximum Daily Loads (TMDLs) of Pollutants*: Congressional Research Services Report for Congress October 30.

Corkal, D. R. & Adkins, P. E. (2008). *Canadian Agriculture and Water*. Paper presented at the 13th IWRA World Water Congress

de Groot, R. S., Wilson, M. A. & Boumans, R. M. J. (2002). A typology for the classification, description and valuation of ecosystem functions, goods and services. *Ecological Economics*, 41(3), 393-408.

Discover Murray. (2008). Murray-Darling Basin Commission. Retrieved February 11, 2009, from <http://www.murrayriver.com.au/river-management/murray-darling-basin-commission/>

ÉcoRessources Consultants, International Institute for Sustainable Developmen & Institut de Recherche et de Developpement en Agroenvironnement. (2008). *Cost-Efficiency Analysis of Possible Environmental Goods and Services (EGS) Policy Options*. Québec City: Agriculture and Agri-Food Canada.

Eigenraam, M. (2009). Measuring environmental change: an innovative solution. Retrieved August 15, 2009, from [http://www.dse.vic.gov.au/CA256F310024B628/0/7076199F8C22FAD8CA2575FA00820580/\\$File/EnSym+AusInnovation+21May09.pdf](http://www.dse.vic.gov.au/CA256F310024B628/0/7076199F8C22FAD8CA2575FA00820580/$File/EnSym+AusInnovation+21May09.pdf)

Eigenraam, M., Strappazon, L., Landsdell, N., Beverly, C. & Stoneham, G. (2006, August 12-18). *Designing Frameworks to Deliver Unknown Information to Support MBIs*. Paper presented at the 26th Conference of the International Association of Agricultural Economists, Gold Coast, Queensland, Australia.

Eigenraam, M., Strappazon, L., Lansdell, N., Ha, A., Beverl, C. & Todd, J. (2006). *EcoTender: Auction for Multiple Environmental Outcomes*. Victoria, Australia: Department of Primary Industries.

Environment Canada. (2006). Municipal Wastewater Survey - Export Data 2006. Retrieved September 3, 2009, from http://www.ec.gc.ca/water/mwws/en/export_tables.cfm

Environment Canada. (2007). 2007 National Pollutant Release Inventory (NPRI) Reviewed Facility Data Release. Retrieved September 3, 2009, from <http://www.ec.gc.ca/inrp-npri/default.asp?lang=en&n=00C79591-1>

Environment Canada. (2008a). Cleaning up Lake Winnipeg: Part of the Government of Canada's Action Plan for Clean Water. Retrieved 2009, February 15, from <http://www.ec.gc.ca/paac-apcw/Default.asp?lang=En&n=61284017-1>

Environment Canada. (2008b). Water Quality Monitoring Locations and Objectives. *Prairie and Northern Region - Prairie Provinces Water Board* Retrieved February 15, 2009, from <http://www.mb.ec.gc.ca/water/fa01/fa01d03/fa01s07.en.html>

Ewaschuk, E. (2005). Watersheds 101. Retrieved March 15, 2009, from http://www.landstewardship.org/Watershed101_000.pdf

Farrow, S. R., Schultz, M. T., Celikkol, P. & van Houtven, G. L. (2005). Pollution Trading in Water Quality Limited Areas: Use of Benefits Assessment and Cost-Effective Trading Ratios. *Land Economics*, 81(2), 191-205.

Feldman, D. L. (2007). *Water Policy for Sustainable Development*. Baltimore, USA: The John Hopkins University Press.

Foster, G. R., Lane, L. J., Nowlin, J. D., Laflen, J. M. & Young, R. A. (Eds.). (1980). *A model to estimate sediment yield from field sized areas: Development of model* (Vol. 26): United States Department of Agriculture (USDA) and Science and Education Administration-Agriculture Research (SEA-AR).

Gassman, P. W., Osei, E., Saleh, A. & Hauck, L. M. (2002). Application of an environmental and economic modeling system for watershed assessment. *Journal of the American Water Resources Association*, 34(1), 73-89.

Glouberman, S., Gemar, M., Campsie, P., Miller, G., Armstrong, J., Newman, C., et al. (2006). A framework for improving health in cities: A discussion paper. *Journal of Urban Health*, 83(2), 325-338.

Greenhalgh, S., Guiling, J., Selman, M. & St. John, J. (2007). *Paying for Environmental Performance: To Allocate Funding For Conservation*. Washington D.C.: World Resources Institute.

Greenhalgh, S. & Selman, M. (2008, February). *Water Quality Trading Programs - A Comparison between the Northern and Southern Hemispheres*. Paper presented at the AARES 52nd Annual Conference, Canberra, Australia.

Greenway, M. & Woolley, A. (1999). Constructed Wetlands in Queensland: Performance Efficiency and Nutrient Bioaccumulation. *Ecological Engineering*, 12, 39-55.

Gunderson, L. & Klang, J. (2004). *Lower Minnesota River Dissolved Oxygen - Total Maximum Daily Load Report*: Minnesota Pollution Control Agency.

Hall, J. C. (n.d.). Minnesota River Trading Program: Win/Win Solution Addressing Economic and Technical Issues. Retrieved February 10, 2009, from http://www.envtn.org/WQT_EPA/Microsoft%20PowerPoint%20-%20John%20Hall%20-%20MN%20River%20Nutrient%20Trading.pdf

Hansen, L. & Ribaud, M. (2008). *Economic Measures of Soil Conservation Benefits - Regional Values for Policy Assessment*. Washington, DC: United States Department of Agriculture.

Huber, W.C. & R.E. Dickinson. (1988). *Storm Water Management Model Version 4, User's Manual*. EPA 600/ 388/ 001a (NTIS PB88-236641/ AS). Athens, GA: U.S. Environmental Protection Agency.

Hung, M. F. & Shaw, D. (2005). A trading-ratio system for trading water pollution discharge permits. *Journal of Environmental Economics and Management*, 49, 83-102.

Keudel, M. (2007). *Water Quality Trading Systems: An Integrated Analysis of Theoretical and Practical Approaches*. Unpublished Doctoral Thesis, University of Cologne, Cologne, Germany.

Lake Winnipeg Stewardship Board. (2006). *Reducing Nutrient Loading to Lake Winnipeg and its Watershed Our Collective Responsibility and Commitment to Action*. Winnipeg: Province of Manitoba - Minister of Water Stewardship.

Leonard, R. A., Knisel, W. G. & Still, D. A. (1987). GLEAMS: Groundwater Loading Effects of Agricultural Management Systems. *Transactions of the American Society of Agricultural Engineers*, 30, 1403-1418.

Liu, Y. B., Yang, W. & Wang, X. (2008). Development of a SWAT Extension Module to Simulate Riparian Wetland Hydrologic Processes at a Watershed Scale. *Transactions of the the American Society of Agricultural and Biological Engineers*, 50(5), 1549-1563.

Manitoba Conservation. (2002). *Manitoba Water Quality Standards, Objectives, and Guidelines, Final Draft: November 22, 2002*. Winnipeg.

Manitoba Land Initiative. (2004). Environment: Wastewater Treatment Facilities Map. Retrieved January 15, 2009, from <https://mli2.gov.mb.ca//environment/index.html>

Martin, S. R. (2007a). Water Quality Trading - A Regulator's Perspective. [Environmental and Land Use Law]. *Florida Bar Journal*(May), 56-59.

Martin, S. R. (2007b, May). Water Quality Trading - A Regulator's Perspective. [Environmental and Land Use Law]. *Florida Bar Journal*.

McCandless, M., Venema, H. D., Barg, S. & Osborne, B. (2008). *Full Cost Accounting for Agriculture (Final Report) – Valuing public benefits accruing from agricultural beneficial management practices: An impact pathway analysis for Tobacco Creek, Manitoba*. Winnipeg, Manitoba: International Institute for Sustainable Development.

McNamara, P. (2007). Murray Darling Basin: drought, over-allocation, conservation. *Trust News Australia*, 14-16. Retrieved from <http://www.heritageatrisk.org.au/2008%20OH@R%20Murray%20Darling.pdf>

Mihelic, J. R. (1999). *Fundamentals of Environmental Engineering*. New York: John Wiley and sons.

Millennium Ecosystem Assessment. (2005). *Ecosystem and human well being: synthesis*. Washington D.C.: Island Press: World Resources Institute.

Minnesota Pollution Control Agency. (2007a, April 13, 2007). Minnesota River Basin. Retrieved February 10, 2009, from <http://www.pca.state.mn.us/water/basins/mnriver/>

Minnesota Pollution Control Agency. (2007b, March 28, 2007). Minnesota River Basin: General Phosphorus Permit - Phase I. Retrieved February 10, 2009, from <http://www.pca.state.mn.us/water/basins/mnriver/mnriver-phosphoruspermit.html>

Minnesota River Basin Data Center. (2003, April 15, 2003). Basin Fast Facts. Retrieved February 10, 2009, from http://mrbdc.mnsu.edu/mnbasin/fact_sheets/fastfacts.html

Murray-Darling Basin Commission. (2001). *Basin Salinity Management Strategy 2001-2015*. Canberra, Australian Capital Territory: Murray-Darling Basin Ministerial Council.

Murray-Darling Basin Commission. (2006). Interstate Water Trade and Salinity - Fact Sheet 6. *Interstate Water Trade* Retrieved February 13, 2009, from http://www.mdbc.gov.au/_data/page/114/MDB3614_Fact_Sheet_6.pdf

Murray-Darling Basin Commission. (2007). MDBC Basin Salinity Management Strategy - 2005-2006 Annual Implementation Report. Retrieved February 13, 2009, from http://www.mdbc.gov.au/subs/dynamic_reports/BSMS%20Implementation%20Report%2005-06/2independent.htm#2_2

Murray-Darling Basin Commission. (2008). *Murray Darling Basin Commission - Annual Report 2007–2008*. Canberra: Ministry of Climate Change and Water.

Nair, S. & Roy, D. (2009). Promoting Variation. In D. Swanson & S. Bhadwal (Eds.), *Creating Adaptive Policies: A Guide for Policy-Making in an Uncertain World*: Sage Publications.

Nguyen, N., Woodward, R., Matlock, M., Denzer, A. & Selman, M. (2006). *A Guide to Market-Based Approaches to Water Quality*. Washington DC: Texas A&M University - Department of Agricultural Economics - University of Arkansas - Department of Ecological Engineering - World Resources Institute.

Nolet, J., Hernandez, M., Olar, M., Brunelle, J.-A., Sauve, C., Venema, H. D., et al. (2008). *Cost-Efficiency Analysis of Possible Environmental Goods and Services (EG&S) Policy Options*. Ottawa, Canada: Agriculture and Agri-Food Canada.

North Carolina Division of Water Quality. (2003). Tar-Pamlico River Basin. Retrieved February 11, 2009, from <http://h2o.enr.state.nc.us/basinwide/whichbasintarpam.html>

O'Grady, D. & Wilson, M. A. (Undated). *Phosphorus Trading in the South Nation River Watershed, Ontario, Canada*. Ontario, Ottawa, Berwick: CH2M-Hill and South Nation Conservation.

Offset Quality Initiative. (2008). *Ensuring offset quality: Integrating high quality greenhouse gas offsets into North American cap-and-trade policy*. Washington: The Climate Trust and Pew Centre on Global Climate Change.

Olewiler, N. (2004). *The Value of Natural Capital in Settled Areas of Canada*: Ducks Unlimited Canada and the Nature Conservancy of Canada.

Organization for Economic Cooperation and Development. (2001). *Domestic Transferable Permits for Environmental Management: Design and Implementation*.

Parker, J. S., Moore, R. & Weaver, M. (2009). Developing Participatory Models of Watershed Management in the Sugar Creek Watershed (Ohio, USA). *Water Alternatives*, 2(1), 82-100.

- Pearce, D. W. (1993). *Economic Values and the Natural World*. Cambridge, MA: MIT Press.
- Pharino, C. (2007). *Sustainable Water Quality Management Policy - The Role of Trading: The U.S. Experience* (Vol. 10). Dordrecht, The Netherlands: Springer.
- Policy Research Initiative. (2004). *Integrated Water Resource Management: Sustainable Development Briefing Note*.
- Prairie Provinces Water Board. (Undated). Sharing a Prairie Resource: Prairie Provinces Water Board. *Prairie Water News* Retrieved February 15, 2009, from <http://www.prairiewaternews.ca/water/vol13no1/story7a.html>
- Prochera, J. (2009). The History of the Red River Basin Commission. In V. Voora (Ed.) (Email ed.). Winnipeg: International Institute for Sustainable Development.
- Province of Manitoba - Environmental Management. (1985). *Design Objectives for Standard Sewage Lagoons*. Winnipeg, Manitoba: Province of Manitoba.
- Ribaudo, M. & Weinberg, M. (2006). Improving Air and Water Quality can be Two Sides of the Same Coin. *Amber Waves*, 4(July 2006), 6.
- Ribaudo, M. O. & Nickerson, C. J. (2009). Agriculture and water quality trading: Exploring the possibilities. *Journal of Soil and Water Conservation*, 64(1), 1-7.
- Rio Declaration on Environment and Development, Agenda 21(1992).
- Roberts, D. C., Clark, C. D., Park, W. M. & English, B. C. (2008). A Spatial Assessment of Possible Water Quality Trading Markets in Tennessee. *Review of Agricultural Economics*, 30(4), 711-728.
- Roy, D., Venema, H. D., Barg, S. & Osborne, B. (2007). *Lake Winnipeg Management Options: Lake Science and Lessons from International Best Practices*. Winnipeg: International Institute for Sustainable Development.
- Ruhl, J. B. (2008). Farms and Ecosystem Services. *Choices*, 23(2), 32-36.
- Sampson, N. (1992). Achieving Public Values on Private Land. *Journal of Soil and Water Conservation*, 47(5), 360-364.

- Saskatchewan Watershed Authority. (2009). Assiniboine Watershed Stewardship Association Pilots Innovative Wetland Restoration Program. *Prairie Update*, 38(Winter), 6.
- Sauve, C., Nolet, J., Whyte, C. & Sanchez, R. (2006). *Water Quality Trading to Address Water Pollution from Agricultural Activities - Assessing the Adequacy of the Canadian Legislative and Policy Contexts*: Government of Canada - Policy research Initiative.
- Schindler, D. W. & Donahue, W. F. (2006). An Impending Water Crisis in Canada's Western Prairie Provinces. *Proceedings of the National Academy of Sciences*, 103, 7210-7216.
- Shabman, L. & Stephenson, K. (2007). Achieving Nutrient Water Quality Goals: Bringing Market-Like Principles to Water Quality Management. *Journal of the American Water Resources Association*, 43(4), 1076-1089.
- Sharpley, A. N., Foy, B. & Withers, P. (2000). Practical and innovative measures for the control of agricultural phosphorus losses to water: an overview. *Journal of Environmental Quality*, 29, 1-9.
- Shkolny, M. (2008, January 23, 2008). *Major Capital Program Challenges to Improve Winnipeg's Water and Wastewater Systems*. Paper presented at the 25th Annual Red River Basin Land and Water International Summit Conference, Fargo, ND.
- Stephenson, K. L., Shabman, L. & Geyer, L. L. (1999). Toward an Effective Watershed-Based Effluent Allowance Trading: Identifying the Statutory and Regulatory Barriers to Implementation. *The Environmental Lawyers*, 5(3), 775-815.
- Tchobanoglous, G. & Schroeder, E. D. (1985). *Water Quality: Characteristics, Modeling and Modification*. New Jersey: Prentice Hall.
- Thampapillai, V. (2006). The Murray-Darling River Basin - Sustainable Development and Water Trade. *Environmental Policy and Law*, 36(1), 42-49.
- Torkil, J.-C. (2004). *Integrated Water Resources Management (IWRM) and Water Efficiency Plans by 2005 - Why, what and how?* : Global Water Partnership, Technical Committee.
- Tri-Star Environmental Consulting. (2006). *Water Quality Trading to Address Pollution from Agricultural Activities in Canada - A Legislative Review*: Government of Canada - Policy Research Initiative.
- U.S. Department of the Interior - Mid-Pacific Region. (2005). Grassland Bypass Project. *Reclamation - Managing Water in the West* Retrieved February 9, 2009, from <http://www.usbr.gov/mp/grassland/>

Ullo, J. F. J. (2007). Water Quality Credit Trading: A Practitioner's Perspective. *The Florida Bar Journal*(May), 60-63.

United States Environmental Protection Agency. (2003). Final Water Quality Trading Policy. Retrieved February 23, 2009, from <http://www.epa.gov/owow/watershed/trading/finalpolicy2003.html>

United States Environmental Protection Agency. (2008). Overview of Watershed Monitoring. Retrieved February 15, 2009, from www.epa.gov/watertrain/monitoring/monitoring6.htm

University, P. (1995). USDA-Water Erosion Prediction Project Hillslope Profile and Watershed Model Documentation. *NSERL Report #10* Retrieved February 15, 2009, from <http://topsoil.nserl.purdue.edu/nserlweb/wepmain/docs/readme.htm>

Voora, V. A. & Venema, H. D. (2008). *An Ecosystem Services Assessment of the Lake Winnipeg Watershed: Phase 1 Report – Southern Manitoba Analysis*. Winnipeg, Manitoba: International Institute for Sustainable Development.

Western Canada Wilderness Committee. (2008). 2008 - Turning the tide on Lake Winnipeg and our health. *Wilderness Committee Educational Report* Retrieved March 15, 2009, from http://historic.wildernesscommittee.org/communities/toxins/reports/Vol27No01/article3/images/02_map.jpg

Williams, J. R., Jones, C. A., Kiniry, J. R. & Spanel, D. A. (1989). The EPIC Crop Growth Model. *Transactions of the American Society of Agricultural Engineers*, 32(2).

Williamson, O. (1985). *The Economic Institutions of Capitalism: Firms, Markets, Relational Contracting*. New York: Free Press.

Wilson, G. A. (2008). Global Multifunctional Agriculture: Transitional Convergence Between North and South or Zero-Sum Game? *International Journal of Agricultural Sustainability*, 6(1), 3-21.

Woodward, R. T., Kaiser, R. A. & Wicks, A.-M. (2002). The Structure and Practice of Water-Quality Trading Markets. *Journal of the American Water Resources Association*, 38(4), 967-979.

Yang, W., Wang, X., Gabor, S., Boychuk, L. & Badiou, P. (2008). *Water Quantity and Quality Benefits from Wetland Conservation and Restoration in the Broughton's Creek Watershed*: Duck Unlimited Canada.

Young, T. F. & Karkoski, J. (2000). Green Evolution: Are Economic Incentives the Next Step in Nonpoint Source Pollution Control? *Water Policy*, 2, 151-173.

Appendix A - Water Quality Trading Design Elements

The general design and suitability of a WQT system is dictated by the pollutant's characteristics (toxicity, breakdown and interdependencies), transport mechanisms (point and nonpoint sources) and receiving medium (characteristics of the water bodies). In addition, the environmental, legal and institutional and economic dimensions need to be considered. These elements are discussed in the following subsections.

A.1 Emission considerations

A number of considerations related to the emissions impacting water quality are required to design a WQT system such as the nature of the pollutant, emission transport mechanisms and the receiving medium. The number and types of emission sources determine whether or not point to point and point to nonpoint source trading needs to be included. Characteristics of the basin may impose temporal and spatial constraints on the WQT system as some areas may be more vulnerable than others.

Pollutants that can be assimilated by the environment within certain concentrations may be well suited for WQT. They must also be examined for interdependencies with other pollutants and if they can combine into impactful substances. For instance, toxic pollutants that cannot be assimilated and accumulate such as heavy metals are best dealt with using regulation, while pollutants that can be organically absorbed by the environment, such as nutrients, can be mitigated using WQT. The degree to which pollutants are absorbed and uniformly mix into water bodies needs to be considered for preventing localized areas of high concentration or “hot spots.” The use of modelling can help establish acceptable concentrations with varying flow conditions to absolute loadings.

Emission transport mechanisms into water bodies are typically characterized as point or nonpoint sources. Point sources (which can be direct and indirect discharges) can be accurately measured as their emissions are discharged in water bodies at specific and identifiable places. In contrast, nonpoint sources are diffuse and are difficult to measure and monitor.

The receiving medium or water bodies also need to be characterized. The background pollution levels, hydromorphology and biology of the water body will influence the ambient concentration (or immission) of a particular pollutant at a specific time and place (see **Figure 17**). The pollutant, transport mechanism and receiving medium characteristics can be captured by dispersion coefficients,²⁰ which link specific emissions at a particular time and place

²⁰ Dispersion coefficients are not always readily available and need to be calculated to assess how the pollutant load at point A will impact point B.

to the ambient concentrations of the pollutant within a water body at another specific time and place.

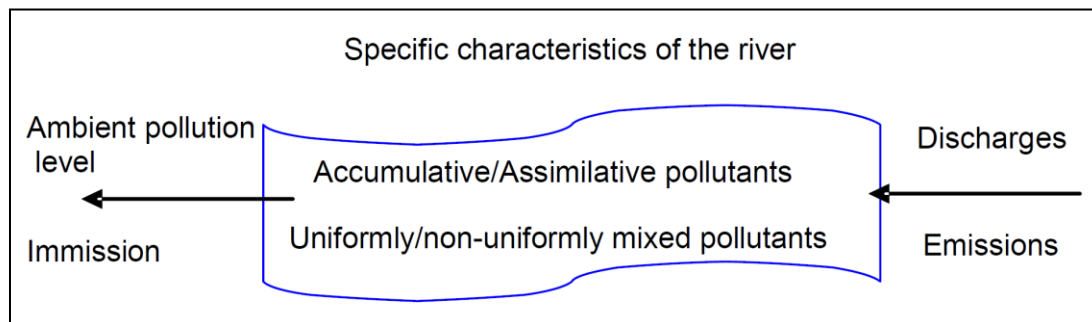

Figure 17: The characteristics of the pollutant emissions and receiving medium will influence the ambient concentration of the pollutant in the water body (Keudel, 2007, p. 19)

To ensure the successful implementation of a WQT system, regulators must have the necessary information to limit pollution activities via permits to achieve water quality objectives. Modelling pollution transport and assimilation provides information to determine suitable caps, allocation of permits and trading performance.²¹ “Water quality modeling would be required to simulate various location patterns of discharge and the outcomes of different zonal boundaries and temporal patterns which may help develop a competitive market” (Pharino, 2007, p. 42). Uncertainties should be assessed when modelling water pollutant transport, as even the most sophisticated water quality models can generate inaccurate information.

A.2 Ecological considerations

The geographical boundary, ecological objectives, upstream-downstream dynamics, establishment of immission and emission caps and trading ratios are important ecological considerations when designing a WQT system. Watershed-based WQT and ecological objectives for endpoints tend to be more environmentally effective than other geographical boundaries. The upstream-downstream dynamics of WQT needs to be understood to avoid the formation of hot spots. Flexible immission and emission caps are preferred to ensure that ecological objectives are met. Trading ratios are used to represent a pollution source’s impact on endpoints and uncertainties associated with nonpoint sources abatement measures.

Although WQT can be implemented based on institutional boundaries, the watershed is the best geographical scope to achieve ecological effectiveness. WQT systems can be nested within different water-bounded spatial extents such as basins for large rivers or watersheds for small rivers. In this

²¹ Modelling requirements will also factor into the overall transactions costs of the WQT scheme.

way large basin goals can be implemented through decentralized sub-watershed level trading. Transboundary basins like the Lake Winnipeg Basin add a level of complexity to the proper design of WQT systems, as ecological objectives must be shared amongst all parties. For this reason, a number of international commissions have been established to facilitate the sustainable management of international watersheds. For instance, the Red River Basin Commission was established in 1996 to coordinate basin level efforts in Canada and the United States to develop and implement water quality, flooding and drought management planning (Prochera, 2009).

Ecological objectives can be defined for a particular point in the river, the water body into which it eventually flows or both. It is generally more ecologically effective to base the objective on an endpoint rather than the instream flow, as the cumulative impacts of the rivers flowing into a water body can be substantial. Endpoint oriented objectives must be linked to the instream flow objectives so that ecological effectiveness can be achieved. Water quantity aspects also need to be considered as they may significantly impact water quality.

A well-designed WQT system will factor in the upstream-downstream nature of the emissions so that hot spots, inefficiencies caused by third party effects and trading asymmetries²² can be avoided. Controlling the number of credits used in susceptible areas, limiting the direction of trades (upstream and downstream) and imposing discharger limits for pollutants that cause local impacts can help avoid the formation of hot spots. The upstream-downstream characterization must lead to a detailed understanding between the emission and immission loads within the WQT system, which is essential to establish caps.

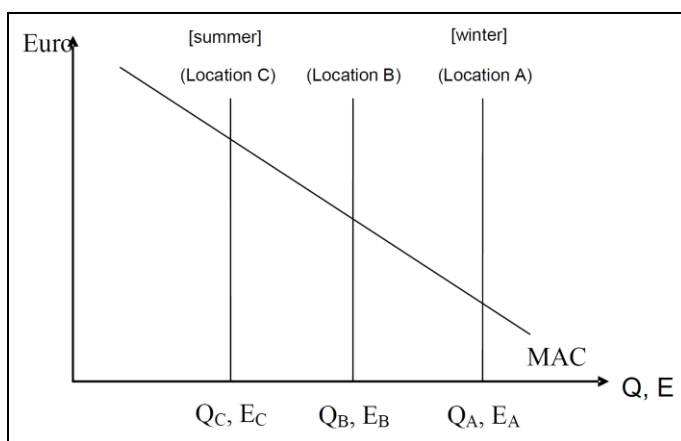

Figure 18: The graph above illustrates an ambient based permit system. The emission cap at location C (E_C) is lower than the other two locations so that the ambient load limit (Q_C) will not be exceeded. The same emission load at point C leads to a greater immission load than at locations B and A and therefore must be

²² Trading asymmetries is an upstream-downstream problem where the first upstream source cannot benefit from nutrient reductions and the last downstream source cannot sell credits as there are no downstream sources that will benefit from the reductions (Keudel, 2007).

more stringent than the other two. The Marginal Abatement Costs (MAC) correspondingly increases with emission reduction requirements (Keudel, 2007, p. 22)

WQT permits and caps can be emission- or ambient-based. An emission-based trading system is independent of source locations and discharge times. For this reason, it cannot achieve a specified ecological objective and ensure permit homogeneity (Keudel, 2007). An ambient- (or immission-) based permit system aims to guarantee a desired water quality. Immission caps need to be converted into emission caps via dispersion coefficients to ensure ecological effectiveness and permit homogeneity. This concept is illustrated in **Figure 18**, which shows how emission loads are differentiated in time and space (A, B and C) so that corresponding water quality standards can be respected.

Permit homogeneity needs to be maintained, meaning that “the discharge from the purchasing source must be equivalent to the discharge avoided by the selling source” (Keudel, 2007, p. 31). Trading permits can be homogenized in their impact to the ambient pollution load by establishing impact trading ratios. A trading ratio is the number of units of pollution reduction a source must purchase to receive a credit for one unit load of reduction. For instance, a 2:1 trading ratio indicates that source 1 must decrease its emissions by 2 units if source 2 increases its emissions by one unit. Trading ratios can be established exogenously or endogenously. Exogenous trading ratios are established at one particular point in time and are not conducive to frequently changing conditions between emissions sources and their water quality impacts. Endogenous trading ratios capture the changing conditions between emissions and immission by being re-adjusted in a timely manner but will raise a WQT system’s transaction costs. For example, the impact trading ratio of a point source emitting into a stream with a highly variable flow would require frequent adjustments to reflect changing hydrologic conditions.

Impact trading ratios should not be confused with uncertainty trading ratios typically applied to nonpoint sources. To ensure ecological effectiveness, an uncertainty trading ratio may be applied to nonpoint sources so that it abates more than it sells in permits. This may be necessary where there is inadequate data to establish a trading ratio based on scientific information.

A.3 Legal and institutional considerations

A shift in regulator responsibility is required to adopt a WQT system. Regulators become market designers and enforcers while regulations focus on environmental constraints and absolute pollution loads as opposed to concentrations. Compatibility with existing legal, institutional and administrative frameworks need to be assessed. For instance, existing best available technology regulations could limit investment choices (Keudel, 2007). To maintain acceptance and practicability, emitters must be kept informed of the advantages and necessities of WQT. Close collaborations between

governments and local efforts are imperative to ensure the successful implementation of a WQT system (Parker, Moore & Weaver, 2009). It is also important to note that, given the complex biophysical and institutional dynamics associated with water quality management, a learning and adaptive culture fostered by close collaborations must permeate the WQT system design.

WQT systems require legally protected discharge entitlements, legally transferable entitlements and enforceable terms of entitlement and transfer (Pharino, 2007). Tradable entitlements or permits can be categorized as flow or stock permits, which are respectively measured in loading rates (kg/hour) and absolute loads (tonnes). A permit's lifetime can be finite or infinite and both types can have review provisions. Short-term permits allow for adaptation to new information, while long-term permits lower planning uncertainties.

Permits need to be allocated to the emission sources before trading can be initiated. Allocation strategies can be once-off or periodic. Periodic allotments can be beneficial as dischargers may engage aggressively in compliance activities to secure allowances. Permit allocations are typically accomplished via an auction or grandfathering process. Auction allocation requires sources to purchase permits from the government at market-clearing prices. Grandfathering allocation entitles sources to permits based on their historical discharge. Additional permits are purchased to cover emissions above initial allocations.

Monitoring mechanisms are required to ensure that WQT systems are effective and trading equivalencies are realized. The monitoring strategy will be influenced by the nature of the pollutant, required accuracy and monitoring costs. Direct (field measurements) and indirect (computer modelling) approaches can be used to gauge environmental effectiveness. Monitoring nonpoint sources is a major challenge that can be addressed by assessing pollution reductions attributed to BMPs and verifying their implementation.

Liability associated with guaranteeing adequate reductions in accordance with the permits sold must be established. For WQT systems, seller liability is more appropriate than buyer liability, as it becomes difficult and costly for the buyer to ensure that the seller is complying with the permit sale conditions (Pharino, 2007). Seller liability, where the environmental authorities monitor reduction measures, is likely to lead to a more efficient trading system (Keudel, 2007).

Enforcement is required to ensure that emitters are complying with WQT rules. Sanctions, which can range from notifications to financial and criminal penalties, should be set to dissuade participants from violations. Enforcement will only be effective if leakage and substitution are avoided. For instance, a company may move to another location where there are no regulations or they may switch to using unregulated pollutants to undermine enforcement efforts.

A.4 Economic considerations

A viable WQT system requires many polluting entities within a watershed that are emitting the same pollutant and are willing to buy and sell discharge permits to meet a regulated target. The number of potential traders will dictate the range of potential marginal abatement costs. Designing an effective WQT system requires economic considerations such as type of trading, market structure, cost-effectiveness, transaction costs, technological advancements and market distortions (Keudel, 2007).

The regulatory agency will specify the types of trades that are allowed and the type of market that will facilitate trading. There are three types of trades that can take place within a WQT system: point-to-point source trading, point-to-nonpoint source trading and nonpoint-to-nonpoint source trading. The WQT market must define and execute the trading process, ensure clear communication between buyers and sellers and assure compliance with water quality regulations. The following types of markets can be used to facilitate WQT (Pharino, 2007):

- Bilateral Negotiations: Sellers and buyers negotiate the trades directly.
- Third Party Broker: Trades between parties are facilitated by a broker.
- Clearinghouse: Credit prices are set for various water quality projects by the clearinghouse.
- Exchange: The exchange market sets the price for transactions.

Cost effectiveness refers to achieving an ecological objective at the least cost. The WQT system must be designed so that there is an incentive for emitters to take advantage of differences in marginal abatement costs (Keudel, 2007). Immission caps can be non-differentiated or differentiated, which will impact the cost effectiveness of a WQT system. A non-differentiated immission cap implies that one cap is set for the entire system, which may lead to a stringent ecological objective and marginal abatement costs. Differentiated immission caps may result in a more cost effective trading system by setting ecological objectives that can change in time and space. Lower marginal abatement costs should be weighed against higher transaction costs.

Transaction costs are defined as the “margin between buying and selling” (Keudel, 2007, p. 42). They can be onetime costs associated with establishing a WQT system or regular costs (trade dependant or independent) needed to maintain the system. They typically originate from information, monitoring and enforcement requirements. A number of factors influence transaction costs such as government oversight, water quality modelling and the establishment of immission and emission caps. The lack of statutory frameworks and monitoring infrastructure will result in additional transaction costs. High transaction costs could impede trading and lowering them as much as possible is imperative to stimulate participation in the WQT system.

Ideally, the WQT system must be designed to promote dynamic efficiency and allow for investments

in new less polluting technologies. The incentive to invest in new technologies is typically driven by the potential benefits of selling permits. Advances in abatement technologies must be considered when designing the WQT system so that innovative activities will not be hampered.

Market distortions such as market power and price fixing, intended pollution inflation and free riding must be considered when designing a WQT system. Market power and cooperative price fixing will lower the ecological effectiveness of the WQT system. If firms participate in non-competitive market trading the public welfare may be impacted. WQT participants may purposefully increase their current pollution levels to sell future reduction credits. Free riders may enjoy the benefits from pollution control by others without taking action. For example, upstream mitigation will benefit downstream polluters regardless of whether or not downstream users do anything.

Appendix B - Water Quality Prediction Techniques

The water quality prediction techniques presented include loading ratio methods, simplified decision-making models and simulating modelling. These approaches are presented in the subsection below.

B.1 Loading ratios

A WQT platform can have a portfolio of BMPs with differing levels of effectiveness as possible offsets. A review of water quality benefits derived from BMPs can be used to assess their effectiveness in a WQT system. Estimates from reports, papers and program documents are based on measurement results or simulation modelling. BMP effectiveness parameters are shown in **Table 7** and **8**.

Table 7: South Nation Conservation phosphorous loading algorithms

Best Management Practice	Calculation Kg of P per year controlled
Milkhouse	Number of cows x 0.69 kg/year (excluding manure)
	Number of cows x 2.76 kg/year (including manure)
Manure Storage Facility	Number of animals x days x phosphorus excreted x 0.30 (feedlot manure)
	Number of animals x days x phosphorus excreted x 0.07 (dairy pile manure)
Clean Water Diversion	Number of animals x days x phosphorus excreted x phosphorous leached x (reduced feedlot runoff vol. / original feedlot runoff vol.) (phosphorous leached = 0.30 for feedlot and 0.07 for dairy manure stockpile)
Livestock Access	Number of animals x days x phosphorus excreted x 0.03
	(multiply by 0.5 for animals with half day access to watercourse)
Septic systems	P savings = P loading (failed) – P loading (functional) Where P loading = 0.6 Kg TP ca-1 year -1 * (Number persons) * (1-A)
Conservation Cropping	0.50 kg/ha x hectares (no-till)
Cover Cropping	0.4 kg x hectares (not updated)
Buffer Strip	0.67 kg x hectares (for a 6-10 m buffer)
Fragile Land Retirement	0.7 kg x hectares (not updated)
Nutrient Management	25 kg x hectares x 0.1 (not updated)

(Source: O'Grady & Wilson, Undated)

Table 8: Example of literature estimates of BMP effectiveness

BMP	Location	Type of estimate	Parameter	Decrease
Zero Till ¹	Upper Maquoketa Watershed, Iowa	Modelled	Organic P	41%
			Phosphate	7%
			Total P	18%
			Organic N	43%
			Nitrate Nitrite N	13% increase
			Total N	9%
Constructed Wetlands ²	Queensland, Australia	Observed	BOD	17%-98%
			TSS	2 to 74 mg/l
			Total N	6 to 62 mg/l
			Ammonia N	0.2 to 50 mg/l
			Nitrate-Nitrite N	0 to 15.8 mg/l

(Source: Gassman, Osei, Saleh & Hauck, 2002; Greenway & Woolley, 1999)

B.2 Simplified decision-making models

Simplified decision-making models facilitate individual water quality trades. They do not have the breadth of simulation models but can accurately guide WQT decision-making based on specific parameters and available information. These models are often tailor-made for specific applications.

The most common example of a decision-making model for WQT is the Catchment Modelling Tool. The tool was developed to link farming systems to groundwater at the catchment scale and it links to other simulation models to predict soil/water/plant interactions, overland flow, soil processes, soil loss, carbon sequestration and groundwater discharge.

Land-use changes and BMPs are assessed based on their performance in three areas: terrestrial biodiversity, aquatic function and salinity mitigation. The proxy for terrestrial diversity is the product of a habitat services score based on biodiversity improvements, and a biodiversity significance score based on biodiversity quality. The proxy for aquatic function is soil erosion in tonnes per hectare. The proxy for salinity is depth to groundwater, where saline land is defined as land where the water table is less than 2m below the surface. BMPs are weighted based on the percentage to which they restore the performance levels to pre-European settlement (1750). The score for land-use changes and BMPs are calculated as follows (Mark Eigenraam, Strappazzon, Landsdell, et al., 2006):

$$\text{Total Score} = \left(\frac{A_i}{D_A} + \frac{S_i}{D_S} + \frac{B_i}{D_B} \right) \times 100$$

A_i = Aquatic Outcome

S_i = Saline Outcome

B_i = Biodiversity Outcome

D_A = Difference between present and pre – settlement aquatic function values

D_S = Difference between present and pre – settlement saline values

D_B = Difference between present and pre – settlement biodiversity values

B.3 Simulation modelling

Hydrodynamic watershed modelling is a complex and rapidly emerging science. Science and engineering have advanced modelling tools to better understand land-use decision-making impacts. These analytical modelling tools are continually being modified and updated by various agencies and firms globally. The models that have been most widely implemented in North America include:

SWMM - Storm Water Management Model was developed by the U.S. EPA as a continuous and single event storm water and combined sewer overflow modelling tool. Primarily designed for drainage modelling applications, it can also model sediment transport using the universal soil loss equation. Runoff is modelled either as a steady state, or by kinematic or dynamic flow routing (Huber and Dickinson, 1988). Initially developed in FORTRAN for DOS execution, Version 5 was released in 2005 with a full Windows interface.

WEPP - The Water Erosion Prediction Project is a continuous simulation erosion protection model developed by the USDA and housed at Purdue University. Rather than relying on empirical models such as USLE, WEPP is process-based and attempts to simulate erosion and hydrology at the fundamental level using physical principles. WEPP is coded in FORTRAN and is now available in Windows interface versions (University, 1995).

CREAMS - Chemical Runoff and Erosion from Agricultural Management Systems is a DOS-based program running FORTRAN code developed in 1980 by the United States Department of Agriculture. It develops estimates of chemical and nutrient runoff from a homogeneous field for single events, or longer-term averages (Foster, Lane, Nowlin, Laflen & Young, 1980). The runoff model is based on the Soil Conservation Service (SCS) curve number model, and the erosion component is based on the Universal Soil Loss equation (USLE). Nutrients and chemicals are either sediment-bound or dissolved, so chemical and nutrient leaching is modelled by linking their chemical properties to either the runoff or erosion subroutines.

GLEAMS - Groundwater Loading Effects from Agricultural Management Systems was originally developed as an extension for CREAMS for groundwater leaching. It also features four components: hydrology, erosion, pesticide transport and nutrients. Unlike CREAMS, which models only single events, GLEAMS expands on the CREAMS treatment of subsurface chemical movement by generating output for the root zone, as well as transport through the root zone and the area below the root zone. The hydrology component has the option of being augmented by linking to evaporation and crop-growth models such as the Priestly-Taylor and Penman-Monteith models. GLEAMS assumes a consistent homogeneous field unit (Leonard, Knisel & Still, 1987).

ROTO - Routing Outflow to Outlets model was the first simulation model designed to act as a continuous simulation model over entire catchments. It can be used in conjunction with SWRRB or EPIC to examine entire watersheds and estimate water and sediment yield on a continual basis. ROTO uses soil and water routing using Manning's equation; sediment yield from MUSLE (Arnold, Williams & Maidment, 1995).

SWRRB-WQ - The Simulator for Water Resources in Rural Basins – Water Quality model is a modification of CREAMS designed to predict hydrology, erosion nutrient and chemical transport in large watersheds, divided into sub-basins. It can operate on a continuous time scale, and can account for landscape changes such as management decisions and BMPs. With weather data as the main driver, SWRRB-WQ provides output on hydrology, sedimentation, nutrients and pesticides from each modelled sub-basin. Runoff is based on the SCS curve number with routing from the Rational Formula; the erosion component is based on the Modified Universal Soil Loss Equation (MUSLE); the chemical component is a modification of CREAMS; and nutrient modelling was taken from EPIC. Crop growth can be simulated, using Ritchie's model, and water quality is simulated by taking the mass-balance. SWRRB-WQ was originally a DOS-based program, with the first Windows interface released in 1993.

HSPF - Hydrological Simulation Program FORTRAN is a comprehensive package for simulating watershed hydrology and quality, primarily for tracking chemical pollutants from both point and nonpoint sources. HSPF is a physically-based model, based on the Stanford Watershed Model.

EPIC - Erosion Productivity Impact Calculator (also referred to as the Environmental Policy Integrated Climate model) is a tool for estimating crop growth, as well as the impact of farming practices. Conceived in FORTRAN, EPIC has erosion, economic, hydrologic, weather, nutrient, growth dynamics and management components, and as a result can convey a range of agri-environmental information (Williams, Jones, Kiniry & Spanel, 1989).

SWAT - Soil and Water Assessment Tool was originally developed in 1993 by the USDA and Texas A&M University. It continuously predicts the effects of management on large river basins. The model is based on the SWRRB-WQ and CREAMS models, adapted for application to large complex watersheds. SWAT works using basic water balance equations, and runs other models to calculate the terms of the equation. Runoff is calculated by the SCS Curve number; erosion is calculated with MUSLE; crop growth in SWAT is based on EPIC. SWAT can now interface with GIS software, simplifying the data entry task. SWAT is rapidly gaining momentum towards being the most widely applied watershed simulation package.

In Manitoba, SWAT is the most widely applied tool for modelling watershed processes. AAFC has funded a five-year program to examine the effects of BMPs within watersheds. The South Tobacco Creek watershed in Manitoba is one of its six case study locations. An integrated watershed model has been assembled in SWAT to test the effects of BMPs on overall nutrient loading to the watershed (Agriculture and Agri-Food Canada, 2007). The model is capable of determining how a particular BMP implemented in a particular location in a watershed will impact nutrient concentrations (Liu, Yang & Wang, 2008).

A second SWAT model was recently completed by Dr. Yang. The model was used to investigate the effects of wetland restoration in Broughton's Creek, which is located in the Little Saskatchewan River watershed in Western Manitoba. The 25,000 ha sub-watershed is divided into 58 sub-basins, and further divided into a total of 177 hydraulic retention units. The model quantifies potential water quality benefits to be realized from restoring native wetlands up to the area they covered in 1968 (Yang, et al., 2008).

CAT1D - The Catchment analysis tool (CAT1D) was created by State of Victoria as a field-scale, farm systems model on a daily basis over long scales. Its purpose is to model the water balance, vegetation dynamics, carbon sequestration, erosion, nutrient dynamics, crop yields and salinity of various agricultural practices. It has been widely applied for such applications as erosion modelling, evaluating cropping systems, designing crop rotations, assessing soil risk and modelling runoff and hydrology (Beverly, et al., 2007). The CAT1D model incorporates models for crop growth, pasture land, forests, livestock, nutrients and salinity (Beverly, et al., 2007; Mark Eigenraam, Strappazon, Landsdell, et al., 2006). It is an expansion of the PERFECT model²³ developed previously, with particular enhancements in the areas of pasture management, forest growth, salinity and runoff as well as the inclusion of additional land-management practices such as crop rotation. This model was assembled by inputting modelling algorithms into MATLAB programming language.

²³ The PERFECT model is a biophysical tool to assess surface dynamics (M. Eigenraam, 2009).

These tools have the potential to be used in WQT systems to assess the environmental benefits of offsets generated by BMPs, such as zero-till, manure management and wetlands restoration. Models such as those developed in SWAT can serve to gauge water quality improvements from particular BMPs which will depend to a large extent on their location within the watershed. In addition, some of the assessment tools presented above can be modified and enhanced to estimate additional benefits from the ecosystem goods and services²⁴ that are generated by BMPs.

²⁴ Ecosystem Goods and Services represent the benefits that human populations derive, directly or indirectly, from the healthy functioning of evolving ecosystems that encompass air, water, soil and biodiversity.

Appendix C - Water Quality Measurement Parameters

The suite of water quality parameters measured must be compatible with the WQT program objectives. Water quality parameters that could be measured to determine the health of the Lake Winnipeg Basin include chemical, physical and biological characteristics.

C.1 Chemical parameters

Dissolved oxygen (DO) is a measure of gaseous oxygen in the water. It is essential for fish and the aquatic environment, and generally enters the water by diffusing from the atmosphere, and as a by-product of photosynthesis. The level of DO is a solid measure of aquatic ecosystem health and is particularly important in waters under threat of eutrophication such as Lake Winnipeg. The decomposition of organic matter such as algae will lead to a reduction in DO levels. The Manitoba Surface Water Quality Guideline (MWQSOG) defines DO levels for surface water, ranging from 3.0 mg/l to 6.0 mg/l for depending on other parameters, however the general guideline is a 30-day average of 5.5 mg/l for cool water, and 6.0 mg/l for cold water (Manitoba Conservation, 2002).

Biochemical Oxygen Demand (BOD) is related to DO in that it is the amount of oxygen required for carbonaceous oxidation of a non-specific mixture of organic compounds. BOD is also a common measure of water quality as it can be influenced by many different chemicals. It is also a solid measure of eutrophication as eutrophic waters contain higher levels of carbonaceous materials, often from dead algae, that decompose. Typically BOD is given as the amount of oxygen required over a five-day period at 20°C. Municipal wastewater plants typically face a legislated requirement that their effluent not exceed 30 mg/l BOD (Manitoba Conservation, 2002).

Phosphorous (P) is an element of prime importance in the Lake Winnipeg watershed as it is determined that P is the key factor in formation of blue green algae in Lake Winnipeg. It is anticipated that P loads will emerge as the trading unit in a WQT system for the basin. Phosphorous is used for corrosion control in water supply and industrial cooling water systems, an ingredient in detergents, a fertilizer for crops. It is a major constituent in human and livestock waste. The P-containing compounds of interest include orthophosphates and polyphosphates. Typically, water quality measurements are made for dissolved and particulate P. There is a narrative water quality guideline of 0.025 mg/l, unless it can be determined that P is not the limiting factor in the aquatic ecosystem, in which case the limit is 0.05 mg/l (Manitoba Conservation, 2002).

Total Kjeldahl Nitrogen (TKN) is a measure of organic nitrogen; nitrogen from *ammonia* or *ammonium ions*. These compounds can occur naturally in water, but are also found in wastewater and agricultural runoff. Ammonia and ammonium compounds are commonly applied to crops as

fertilizer; they also result from enzymatic decomposition of urea. As part of the nitrogen cycle, these compounds oxidize to nitrites and nitrates. Ammonia is a toxin and can harm aquatic biota. There is a MWQSOG for ammonia in surface waters, which is highly dependent on water temperature and pH (Manitoba Conservation, 2002). Ammonia can indicate pollution from human or animal waste or from cropland where ammonium fertilizers are used. Because it rapidly oxidizes to nitrites and nitrates, its presence indicates recent pollution (Mihelic, 1999; Tchobanoglous & Schroeder, 1985).

Nitrate Nitrite Nitrogen (NO_2^- , NO_3^- , N) is the primary measure of inorganic nitrogen in water and soil. Nitrates and nitrites enter watersheds as agricultural runoff, and from wastewater effluent. Nitrites can be harmful to the blood of fish, and nitrates can replace haemoglobin in human blood, preventing the flow of oxygen. This is known as blue baby syndrome. Besides their toxic effects, these compounds are also major contributors to eutrophication as they are nutrients essential for plant life. There is a Manitoba water quality objective of 10 mg/l of nitrite nitrate nitrogen in groundwater for human consumption, and an aquatic habitat guideline of 0.06 mg/l for nitrite.

C.2 Physical parameters

Turbidity is a measure of the clarity of water. Measured in net turbidity units (NTUs), it is a measure of the amount of colloidal particles in water determined by the level to which water transmits light. Absorption of light is a measure of colloidal particles, and higher NTU levels denote more impurities. Manitoba has a maximum acceptable concentration of 1 NTU in drinking water. In surface water, increased turbidity is a measure of erosion or leaching.

Total Suspended Solids (TSS) is a measure of the total amount of solid particles in suspension, solution, colloids as well as those that settle. The measure of solids can be further refined by determining the quantities of solids that do and do not volatilize at 550°C. TSS in surface water is a measure of erosion, as the particles in the waters have generally been eroded from fields in the watershed or from shorelines. In the Lake Winnipeg context, chemicals such as nitrogen and phosphorous can be fixed to and transported by these particles. In prairie streams and waterways, light penetration can be a limiting factor and TSS can indicate the extent to which carbonaceous matter will decompose. Typically, wastewater effluent in Manitoba has a mandated limit of 30 mg/l of TSS, while the surface water quality objective depends on the background level, and is generally for a 30-day average induced change of 5 mg/l (Manitoba Conservation, 2002)

C.3 Biological parameters

Coliform bacteria include all aerobic and facultative anaerobic, gram negative, non-spore forming, rod-shaped bacteria that can ferment lactose. Fecal coliform bacteria originate in the stomachs of warm-blooded animals. *Escherichia coli* is one species of fecal coliform bacteria. Fecal coliform

bacteria are the main indicator of contamination from human and animal waste in food and water. Correlation of coliform bacteria to other parameters such as nitrogen and phosphorous can help to determine if nutrient loading in a specific area is from cropland or from feces. Common coliform measures include total coliform, fecal coliform and e coli, measured in colony-forming units (CFUs) by culturing a diluted water sample. Manitoba has strict regulations for these organisms. There should be no fecal coliform in drinking water; the limit for recreational use of surface water is 200 CFU/100 ml; wastewater effluent cannot contain more than 200 CFUs of fecal coliform per 100 ml and irrigation water must not have more than 1000 CFU/100 ml and 200 CFU/100 ml of fecal coliform (Manitoba Conservation, 2002).

Appendix D - Valuing Ecosystem Goods and Services

The Millennium Ecosystem Assessment (2005) categorizes EGS into four categories: supporting services, provisioning services, regulating services and cultural services. EGS are intricately linked to human health and well-being. For this reason, the Millennium Ecosystem Assessment stressed the need to enhance and protect these services.

The concept of environmental value comes from the assumption that natural resources have an economic value to society. The various means by which EGS and can be valued is described as Total Economic Value (TEV), which can be broken down into use values, non-use values, and future-use values (Bateman, Lovett & Brainard, 2003; Pearce, 1993).

Use Values are the benefits gained from the utility of EGS, which can be broken down as follows:

- **Direct use value:** The value of the use of the resource, for whatever purpose. Agricultural land can produce crops, but it can also provide biomass for energy generation, perhaps forage for animals, and so on. Some of these values will not be easy to quantify.
- **Indirect use value:** These correspond to “ecological functions,” such as protecting watersheds from siltation, or maintaining biodiversity. Carbon sequestration would be an indirect use value, until there is a market for it in a trading system-at which point sequestration will become a direct value.
- **Option values:** These are also direct values, even though they do not require that there be any specific use of the item at this time. Option values are those that individuals are willing to pay for maintaining the availability of something for their future use, even though the individual has not and may never see it. Old growth forests in British Columbia might be an example.

Non-use values are realized from the fact that something exists, whether it has a use value or not:

- **Existence value:** This is an indirect value, in contrast to the categories listed above. It is the result of people’s willingness to pay for something with no expectation that they themselves will benefit from it. People contribute to organizations to save the Amazonian rain forest or gorillas in Africa, because they feel that these natural wonders should not be destroyed.

Future-use values recognize the fact that, while something may not have a use or non-use value at present, it may in future:

- **Bequest value:** An indirect value that accounts for the value of an environmental asset to future generations. Bequest value is made up of the use values and non-use values that future generations can benefit from.

There is a category of non-economic values as well, often called intrinsic values. These values do not depend on human willingness to pay for them, but are intrinsic to the animal, ecosystem or other part of nature.

According to Pearce (1993) the above listing does not include the value of the system as a whole.²⁵ The topic is discussed by Bockstael, et al. (2000), who point out that the calculation of economic values outlined by Pearce is done by measuring a change in value from one specified state to another, and that both states have to be feasible and comprehensible to individuals for the valuation calculation to have meaning.

There are several methods for environmental valuation. These methods have been developed by economists, engineers and policy-makers. The various approaches to valuation that have been used to date are divided into three broad categories.

- **Market prices and revealed willingness to pay:** includes prices directly set in markets and inferred from market prices. Methods include: direct estimation of producer and consumer benefits, productivity, hedonic pricing method and the travel-cost method.
- **Circumstantial evidence and imputed willingness to pay:** the amount that people are willing to pay to avoid floods can suggest the value of wetlands that will perform this service. The specific methods in this category include damage cost avoided, replacement cost and substitute cost methods. These methods estimate ecosystem costs by estimating the cost of damages due to lost services, the cost of replacing services or the cost of substituting for such services.
- **Stated willingness to pay:** captures people's willingness to pay for a given EGS. The types of survey methods include contingent valuation method and contingent choice method.

Benefit Transfer is another valuation concept, involving the transposition of benefits from one study site to another (Brouwer, 2000). Benefit transfer provides a methodology by which valuations obtained in one study can be used elsewhere, in situations shown to be similar enough that such a transfer is reasonable. Transferring values essentially involves directly applying values calculated elsewhere and applying them to specific cases. Meta-models are a means of systematizing the transfer of functions. At this point in the study of environmental valuation, established values for certain goods and services have yet to be firmly established for all contexts, so meta-models provide

²⁵ By pointing this out, Pearce (1993) acknowledges that the whole is greater than the sum of its parts and advocated for valuing "system characteristics."

a way to develop defensible estimates for valuating ecosystem services when resources do not allow for comprehensive study.

Appendix E - Water Quality Trading and Best Management Practices

BMPs have different levels of cost effectiveness to generate particular environmental benefits. **Table 9** shows estimated implementation costs per hectare and phosphorus reduction cost effectiveness for various BMPs in the Little Saskatchewan watershed. **Figure 21** shows the level of producer uptake modelled in the Little Saskatchewan River watershed for various prices for phosphorous reduction credits. It is important to note that different practices will have differing levels of effectiveness at reaching an environmental objective independent of private cost. The cost effectiveness of reducing phosphorous with BMPs ranges from CDN\$19 to \$416 per kg of P per year when 75 per cent reductions in phosphorous loading are modelled. In comparison, the City of Winnipeg's investment in wastewater treatment infrastructure is approximately \$112 per kg of P per year (McCandless, et al., 2008; Shkolny, 2008).

While the City of Winnipeg's wastewater treatment investments may be less expensive at reducing phosphorous in some instances, these investments will yield only phosphorous reductions. Investments in BMPs will also yield co-benefits that can achieve other EGS objectives, such as habitat restoration and preservation, flood control, water storage and carbon sequestration (Ribaudo & Weinberg, 2006).

Table 9: Phosphorous abatement costs for BMPs in the Little Saskatchewan River watershed and for wastewater treatment (ÉcoRessources Consultants, International Institute for Sustainable Development & Institut de Recherche et de Développement en Agroenvironnement, 2008)

Practice	Annual Cost (CDN\$/ha)	Cost effectiveness (over an assumed 9 year contract) (CDN\$/kg P)
Wooded Riparian Buffer zones	295.00 (1 st year) 61.78 (subsequent years)	224
Grassed Riparian Buffer Zones	61.78	19
Wetlands (one-time payment)	61.78	416
Cover Crops	13.90	262
Manure Storage	329.15/head (first year), 0 (subsequent years)	41
Wastewater Treatment Plant Investments for the City of Winnipeg		112

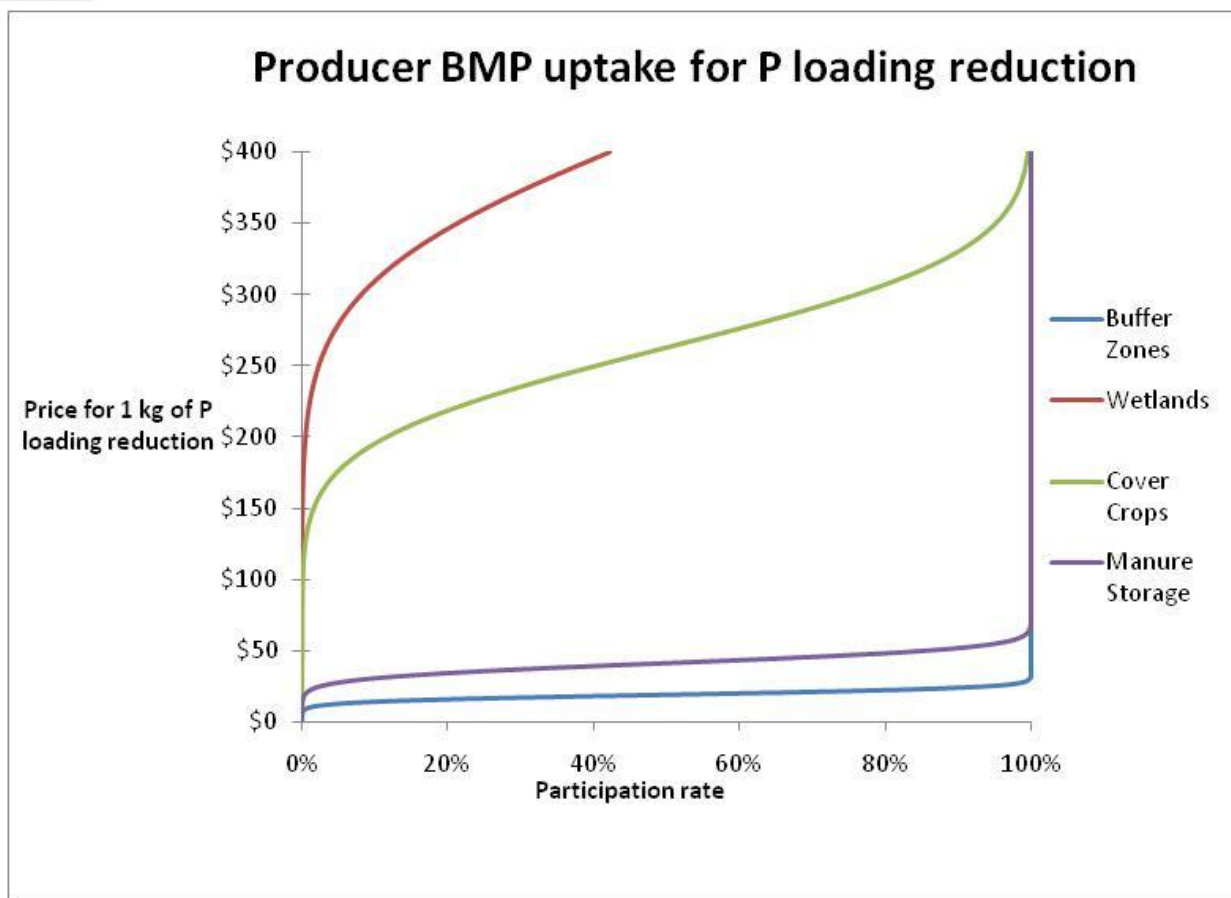

Figure 19: Producer uptake of BMPs at various credit price levels in the Little Saskatchewan River watershed

The benefits associated with converting cropland to zero-till and to permanent cover in the South Tobacco Creek were analyzed by McCandless et al. (2008). The benefits examined included carbon sequestration and phosphorous, sediment loads and waterway sedimentation costs. This analysis revealed that phosphorous reductions account for only a portion of the value provided to society (16 per cent of benefits evaluated for zero-till, and 35 per cent for permanent cover).²⁶ In a WQT program the BMP implementers are paid strictly for the phosphorous reduction benefits realized by the practice.

²⁶ It must be noted that phosphorus and sediment loads are typically highly correlated.

Table 10: Public benefits from converting cropland to zero-till in the Tobacco Creek Watershed (McCandless, et al., 2008)

Zero-Till Benefits	Annual value per hectare of BMP in Canadian dollars
Reduced phosphorous loading	\$ 13.48
Reduced sediment load	\$ 59.86
Reduced sediment deposition in conveyances	\$ 5.20
GHG benefits	\$ 1.80
Total	\$ 80.34

Table 11: Public benefits from converting cropland to permanent cover in the Tobacco Creek Watershed (McCandless, et al., 2008)

Conversion to Permanent Cover	Annual value per hectare of BMP in Canadian dollars
Reduced phosphorous loading	\$ 52.64
Reduced sediment load	\$ 83.25
Reduced sediment deposition in conveyances	\$ 7.23
GHG benefits	\$ 6.60
Total	\$ 149.72

EcoRessources and IISD analyzed five policy instruments to generate water quality improvement in two separate watersheds. In both cases auction-based systems²⁷ and WQT were the most cost-effective water quality improvement funding methods (see **Tables 10** and **11**).

Table 12: Estimated cost in Canadian dollars of delivering water quality improvements in a Quebec watershed

Nicolet River (East Arm) Watershed (Quebec)	One-time payments	Annual payments	Mixed one-time/annual payments	Auctions	Tradable permits
	(Million \$)	(Million \$)	(Million \$)	(Million \$)	(Million \$)
Total benefits	4.40	4.40	4.40	4.08	-
Total costs	2.17	5.85	2.11	1.19	-

Table 13: Estimated cost in Canadian dollars of delivering water quality improvements in a Manitoba watershed

Little Saskatchewan River Watershed (Manitoba)	One-time payments	Annual payments	Mixed one-time/annual payments	Auctions	Tradable permits
	(Million \$)	(Million \$)	(Million \$)	(Million \$)	(Million \$)
Total benefits	0.53	0.53	1.52	1.52	1.52
Total costs	2.82	7.46	0.68	0.394	.400

²⁷ Reverse auctions are environmental market-based instruments that aim to achieve multiple environmental outcomes. Financial incentives are provided by public institutions to landowners who compete to supply ecosystem goods and services. This process allows for investments in the most cost-effective environmental improvements.

Appendix F - Manitoba Environmental Act Licenses

This section outlines the licensing of point source discharges of wastewater effluent to Manitoba watersheds. Within Manitoba, BOD concentrations are currently stipulated and specific nitrogen and phosphorous releases remain unregulated. Because wastewater concentrations are given in BOD, precise quantities of N and P can only be inferred by assuming standard concentrations. In addition, wastewater treatment licences are issued for 20-year periods and are sized to account for population growth. For communities experiencing growth, the maximum loading permitted will not occur until the final year in which the licence is valid. Therefore, the current regime of licensing wastewater treatment facilities in Manitoba on a 20-year basis means that permitted nutrient loadings from wastewater facilities will continue to increase.

The Province of Manitoba regulates releases of treated wastewater effluent to receiving waters. These releases are governed by regulations under the Environment Act (C.C.S.M. c. E125). In order to operate a wastewater facility, a licence must be granted by the Minister of Conservation, pursuant to the Act and its regulations. Licences are typically in effect for 20 years, after which time a new licence must be granted. While there are no regulated provisions for wastewater effluents, there are several guiding policy documents. The Draft Manitoba Water Quality Standards Objectives and Guidelines (Manitoba Conservation, 2002), while still in draft, sets out water quality standards for wastewater effluent, as well as objectives for water in the environment, and standards for drinking water. The water quality standards are set out for wastewater in several categories: municipal wastewater effluent, metal mining effluent, and pulp and paper mill effluent. Standards for municipal wastewater effluent, based on the Canadian Council for Ministers of the Environment standard, is as follows:

- 200 fecal coliform organisms per 100 ml
- 30 mg/l BOD
- 30 mg/l TSS

Most municipalities in Manitoba treat wastewater in stabilization ponds, or lagoons. There are over 400 wastewater facilities licensed in Manitoba, and over 80 per cent of these are lagoons (see **Figure 20**). These facilities permit natural aerobic digestion of organic waste. Lagoons are typically the most cost-effective wastewater treatment option, especially in areas with available land and abundant clay resources that can be used as a liner to prevent leakage to groundwater.

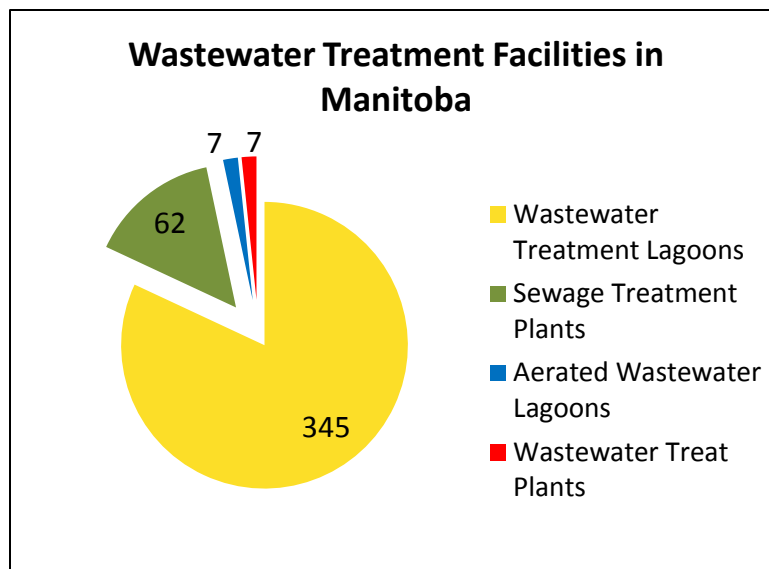

Figure 20: Wastewater treatment facilities in Manitoba (Source: Manitoba Land Initiative, 2004)

Lagoons in Manitoba are designed according to objectives set out by the Province (Province of Manitoba - Environmental Management, 1985). They must be sized to accommodate organic loading at a rate of 56 kg of BOD per day for each hectare of primary cell surface loading and to store all hydraulic loading over a 227 day period between November and June (Province of Manitoba - Environmental Management, 1985). As licences are typically granted for durations of 20 years, it must be demonstrated in the application that the lagoon design will be adequate 20 years into the future. This involves incorporating population and industrial growth projections during the facility design. Thus, in a growing community, peak organic loading allowed under the terms of the licence will not occur until 20 years in the future.

The process for acquiring a licence involves having the proponent complete an application that details facility design, projected loadings, and monitoring and mitigation measures. This application is submitted to Manitoba Conservation, who then circulates it among other federal and provincial departments for comment. For instance, the Water Stewardship Department Ecological Services division reinforces the need for adequate projections of future loading. If there are no comments, a licence is issued. However, in most cases there are comments that are compiled by the approvals and licensing branch of Manitoba Conservation and returned to the proponent for necessary modifications.

Appendix G - The Trading Ratio Model

The trading ratio model achieves ecological objectives at minimum costs by taking advantage of water's uni-directional flow and accounting for location-specific emission impacts. "The extent and spatial pattern of environmental damage to the environment depend not only upon the level of emissions but also upon the locations and transfer characteristics of the emissions" (Hung & Shaw, 2005, p. 84). Its salient features are the following:

- Zonal effluent caps are set by accounting for pollutant loads from upstream zones.
- The trading ratio is set equal to the external transfer among zones.
- Permits are traded amongst the emitters according to the trading ratios.

Implementing the Trading Ratio Model consists of six steps. Monitored water quality zones are first established (see **Figure 21**). "A zone is defined as an area in which the dispersion characteristics of effluents and the environmental effects of any unit of effluent are very close" (Hung & Shaw, 2005, p. 86). The regulator or environmental authority establishes standards for each zone based on the water uses or existing emission standards. Zonal caps are determined sequentially by moving from the upstream to downstream zones. The caps at each zone will be equal to its emission standard minus the emission load originating from the upstream zones. The zonal caps are converting into a number of tradable discharge permits for each zone. The effluent cap-and-emission standard at zone 1 are equal (see **equation 1**). The effluent cap at zone j is equal to the emission standard at zone j minus the sum of discharge permits multiplied by their dispersion coefficients (see **equation 2**).

Downstream zones that have stringent water quality standards constrain the total load standard in the immediate upstream zone (see **equation 3**).

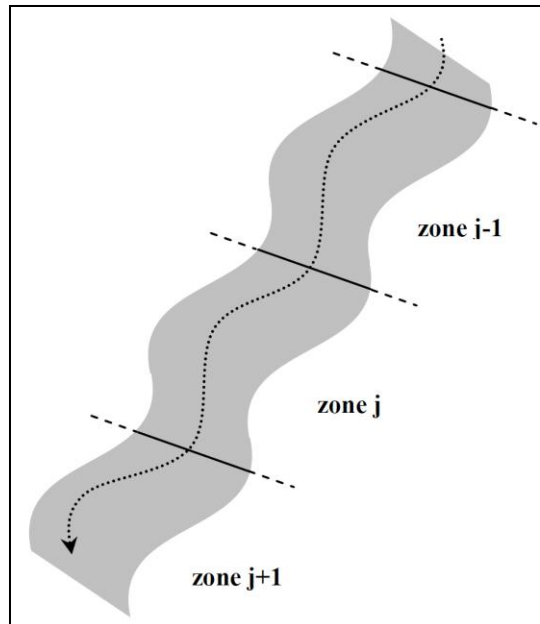

Figure 21: The trading ratio model uses a zonal approach to design a water quality trading system (Keudel, 2007, p. 83)

1. $\bar{T}_1 = E_1$ $\bar{T}_1 =$ Number of discharge permits at zone 1
 $E_1 =$ Emission standard at zone 1
2. $\bar{T}_j = E_j - \sum_{k=1}^{j-1} t_{kj} \bar{T}_k$ $\bar{T}_j =$ Total discharge permits at zone j
 $\bar{T}_k =$ Total discharge permits upstream from zone k
 $E_j =$ Emission standard at zone j
 $t_{kj} =$ Dispersion coefficients from upstream zone k to zone j
3. $\bar{T}_j = \frac{E_j}{t_{(j-1)j}} - \sum_{k=1}^{j-2} t_{kj} \bar{T}_k$

The environmental authority allocates permits to the dischargers in each zone. The total number of permits cannot be exceeded in each zone regardless of the number of dischargers. Impact trading ratios are set based on dispersion (or transfer) coefficients, which correspond to the contribution of one unit of effluent in an upstream zone to the total effluent load to a downstream zone. In essence, the trading ratio or dispersion coefficient t_{kj} represents the total effluent load a discharger in zone j can emit if he purchased one unit from a discharger in zone k. Dischargers then trade based on trading ratios and their total emissions cannot exceed their initial permit allocation plus the permits purchased minus the permits sold (see **equation 4**). Regulators must verify that dischargers emit below their total discharge permits within each zone to ensure that water quality standards are not violated.

$$4. \quad e_i \leq \bar{T}_i + \sum_{k=1}^{i-1} t_{ki} T_{ki} - \sum_{k=i+1}^n T_{ik}$$

The main advantage of the trading ratio model is that downstream impacts are considered and ecological effectiveness is maintained. Free riding is essentially eliminated since all permits allocated are linked via the dispersion coefficients. Monitoring is required only for critical zones, which lowers transaction costs. Preventing the formation of hot spots within a WQT system typically requires a network of receptor points that must be monitored. Adding more zones within a Trading Ratio Model does not significantly increase transaction costs since each zone is defined as an area where environmental impacts are similar regardless of emission source location.

Transaction costs are kept low as the trading rules are simplified and based on pre-determined transparent impact trading ratios. Market distortions such as market power are consequently minimized. Dischargers cannot purchase permits from downstream zones as the trading ratio will be zero. This can only happen if a downstream zone decides to sell a purchased permit originating from a more upstream zone than the discharger buying it. For zones that have aggregate effluents lower than the zonal cap, excess permits can be sold to downstream zones.